

Collection of specification grade downlights for architectural applications. Excellent build quality with features for the most demanding professional applications. Available in five sizes 2", 3", 4", 5", 6" aperture with generous light outputs and excellent chromatic performance. Professional optics available with directional distribution.



OPTIC	BEAM ANGLE	SYSTEM POWER** (W)	OUTPUT (Nominal Luminous Flux)	LUMENS* (lm)	EFFICACY (lm/W)	MAX CANDELA* (cd)
Spot	25°	41	46 (4600 lm)	4 258	104	19 559
Narrow Flood	30°			4 598	112	16 153
Flood	40°			4 677	114	9 423
Wide Flood	55°			4 485	109	5 738
Fixed Wall Washer			28 (2800 lm)	2 856	69	2 205

* Based on round (R) shape, trim (T) mounting and adjustable (A) optic at 3000K, 90CRI.
For Fixed Wall Washer (FWW) optic, based on round (R) shape and trim (T) mounting at 3000K, 90CRI.
** System power corresponds to the maximum measured value considering the Power Factor.
For Non-IC (RF and NC installations), the system power (W) may increase by up to an additional 3W.
Accordingly, the efficacy may vary depending on the resulting system power.

Source: COB LED module
2700K: 90CRI
3000K: 90CRI
3500K: 90CRI
4000K: 90CRI

Lumen maintenance: 90% of initial lumens at 50 000 hours (L90, LM-80)

Optic: *Adjustable:* Deep recessed adjustable lens available with different optics. Optical assembly hot-aiming adjustment — 30° tilt and 355° pan.
Fixed: Deep recessed lens available with different optics.
Fixed Wall Washer.

Material: *Body:* Die-cast aluminum optical assembly
Lens: Optical-Grade PMMA
Baffle: Painted polycarbonate

Mounting: *Cut-out:*
• Round - \bigcirc $\varnothing 6''$ - $\varnothing 6\frac{1}{8}''$ ($\varnothing 153\text{mm}$ - $\varnothing 156\text{mm}$)
• Square - \square $5\frac{1}{8}''$ - $\varnothing 6''$ ($\square 150\text{mm}$ - $\square 153\text{mm}$)
Remodel
New construction with plaster frame
(See page 3 for details)

Electrical: Integral high efficiency LED driver rated at 50 000 hours, 120V or 277V

Dimming: Leading edge (TRIAC) and trailing edge (ELV) (120V only), down to 5%.
0-10V (120-277V), down to 1%.
DALI (120-277V), down to 1%.
Lutron Hi Lume® 1% EcoSystem™ (Soft-on, Fade to Black)
Casambi (120-277V), down to 1%.
Athena Wireless Node (120-277V), down to 1%.

Finish: Powder coated body and baffle
(See page 2 for details)

Weight: 4.95lbs (2.25kg)

Warranty: 5-year limited warranty

Rating: IP20

Certification:  cULus listed for damp location. Interior use only.

CASAMBI  LUTRON.

ORDERING INFO



PRODUCT CODE					INSTALLATION CODE (SEE PAGE 3)				
MODEL	SHAPE	MOUNTING	INSTALLATION	OUTPUT**	LED	OPTIC	VOLTAGE	FINISH (trim finish / baffle finish)	DIMMING***
LOGP6 LOGO PRO 6	R Round	T Trim	RF Remodel	28 ² 2800 lm (41W*)	927 2700K, 90CRI	ASP Adjustable, Spot (25°)	120 120V	White trim	RF, NC (INSTALLATION) 120V LTE Leading and Trailing edge dimming (down to 5%) D10 0-10V (down to 1%) DA ¹ DALI (down to 1%) D2B ^{1 5} Lutron Hi Lume® 1% EcoSystem™ (Soft-on, Fade to Black) 277V D10 0-10V (down to 1%) DA ¹ DALI (down to 1%) D2B ^{1 5} Lutron Hi Lume® 1% EcoSystem™ (Soft-on, Fade to Black) WIRELESS CONTROL 120V or 277V CAS ⁶ Casambi connectivity (down to 1%) AWN ⁶ Athena wireless node connectivity (down to 1%)
	S Square	L Trimless Mud	NC New construction	31 3100 lm (28W*)	930 3000K, 90CRI	ANF Adjustable, Narrow Flood (30°)	277 277V	01 ⁴ White / white	
		M ¹ Trimless Millwork		34 3400 lm (30W*)	935 3500K, 90CRI	AFL Adjustable, Flood (40°)		21 White / black	
				37 3700 lm (33W*)	940 4000K, 90CRI	AWF Adjustable, Wide Flood (55°)		13 White / matte anodized	
				40 4000 lm (35W*)		FSP Fixed, Spot (25°)		41 ¹ White / gold	
				43 4300 lm (38W*)		FNF Fixed, Narrow Flood (30°)		E4 ¹ White / chrome	
			46 4600 lm (41W*)		FFL Fixed, Flood (40°)		E7 ¹ White / black chrome		
					FWF Fixed, Wide Flood (50°)		E9 ¹ White / gold matte		
					FWW ³ Fixed, Wall Washer		Black trim		
							23 Black / white		
							02 Black / black		
							33 Black / matte anodized		
							42 ¹ Black / gold		
							F3 ¹ Black / chrome		
							F1 ¹ Black / black chrome		
							F4 ¹ Black / gold matte		

ACCESSORY

(TO BE ORDERED SEPARATELY)

- 9003-02** - Honeycomb louver
- Available for adjustable (**ASP, ANF, AFL, AWF**) optics



⁽¹⁾ May require a longer lead time than standard. Please contact customer service for details.

⁽²⁾ Fixed wall washer (**FWW**) optic is available only for 2800 lm Nominal Luminous Flux (**28**) Output.

⁽³⁾ Available only for White trim with White baffle (**01**) or Matte anodized baffle (**13**) finish, Trimless with White baffle (**01**) or Matte anodized baffle (**51**) finish.

⁽⁴⁾ For fixed wall washer (**FWW**) optic, it may require a longer lead time.

⁽⁵⁾ Available only for 2800 lm (**28**) output with fixed wall washer (**FWW**) optic, 3100 lm (**31**) and 4600 lm (**46**) outputs.

⁽⁶⁾ Will be available soon. Please contact customer service for details.

* For Non-IC (**RF** and **NC** installations), the system power (**W**) may increase by up to an additional 3W.

** Nominal Luminous Flux value at 3000K, 90CRI. Actual performance may vary depending on the installation conditions.

*** Dimming levels will vary depending on the dimmer used and the number of luminaires on the line.

INSTALLATION
(TO BE ORDERED SEPARATELY)

Remodel (RF)

Versatile fixture for new or existing ceiling structure. Suitable for non-insulated ceiling like sheetrock or paneling. Fixture is ready for remodeling installation. Trimless frame kit can be shipped separately.

Total weight: 4.95lbs (2.25kg)

Ceiling thickness

- Trim (Round / Square): 1/8" - 1 1/8" (1 - 35mm)
- Trimless Mud (Round / Square): 1/8" - 1 1/8" (1 - 35mm)
- Trimless Millwork (Round / Square): 1/2" - 1" (12.5 - 25mm)

Model	Shape	Mounting	Trimless frame	Cut-out dimensions	Clearance (H)
LOGO PRO 6	Round	Trim		Ø6" (Ø153mm)	9 7/16" (240mm)
		Trimless Mud	TK-LOGP6RL-RF*	Ø6 1/8" (Ø156mm)	
		Trimless Millwork	TK-LOGP6RM-RF*	Ø6 1/8" (Ø156mm)	
	Square	Trim		□5 5/8" (□150mm)	
		Trimless Mud	TK-LOGP6SL-RF*	□6" (□153mm)	
		Trimless Millwork	TK-LOGP6SM-RF*	□5 5/8" (□150mm)	

*Can be installed from below the ceiling.

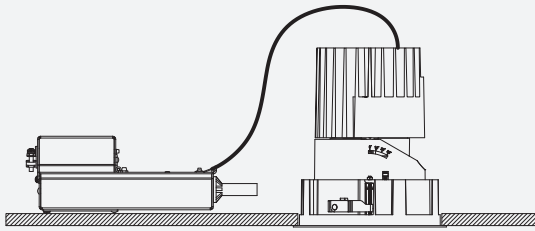

New construction with plaster frame (NC)

Plaster frame with hanger bars system to be installed during rough-in phase. Suitable for non-insulated new construction ceiling assemblies, like sheetrock, or paneling. Plaster frame and trim can be shipped separately.

Total weight: 6.6lbs (3kg)

Ceiling thickness

- Trim (Round / Square): 1/8" - 1 1/8" (1 - 34mm)
- Trimless Mud (Round / Square): 1/8" - 1 1/8" (1 - 34mm)
- Trimless Millwork (Round / Square): 1/2" - 1 1/8" (12.5 - 24mm)

Hanger bars suitable for Grid ceiling

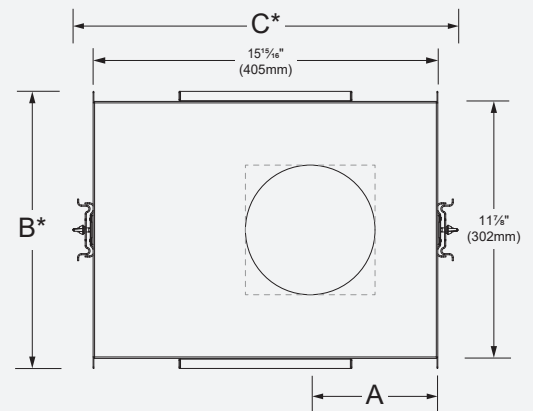
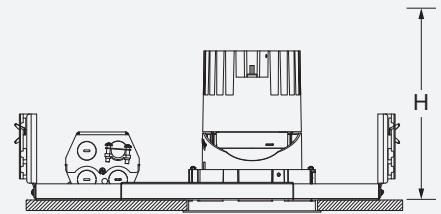
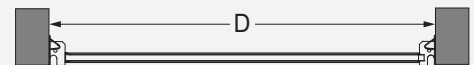
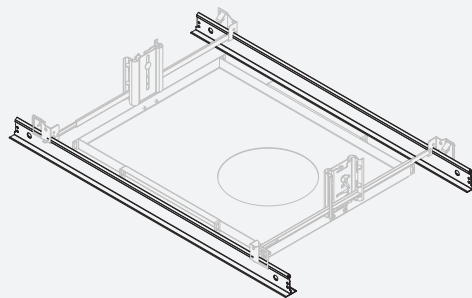

Model	Shape	Mounting	Plaster frame	Cut-out dimensions	Cut-out position (A)	Max overall dimensions (B*xC*)	Hanger bars (D)	Clearance (H)
LOGO PRO 6	Round	Trim	BN-LOGP6RT-NC	Ø6" (Ø153mm)	5 1/8" (150mm)	12 3/16" x 17 13/16" (326 x 453mm)	14 1/4" to 26" (362 to 660mm)	9 7/16" (240mm)
		Trimless Mud	BN-LOGP6RL-NC	Ø6 1/8" (Ø156mm)				
		Trimless Millwork	BN-LOGP6RM-NC	Ø6 1/8" (Ø156mm)				
	Square	Trim	BN-LOGP6ST-NC	□5 5/8" (□150mm)				
		Trimless Mud	BN-LOGP6SL-NC	□6" (□153mm)				
		Trimless Millwork	BN-LOGP6SM-NC	□5 5/8" (□150mm)				

*Provide a minimum of 1 7/8" (47mm) on each side for the hanger bar fixations

MODEL

ROUND TRIM



ROUND TRIMLESS

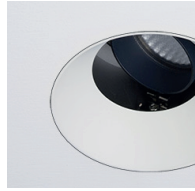

SQUARE TRIM



SQUARE TRIMLESS



7 1/2"
(190mm)

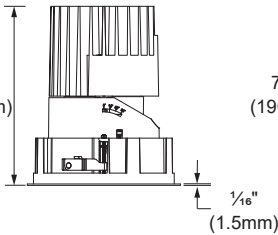

7 1/2"
(190mm)

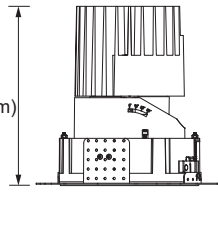

7 1/2"
(191mm)

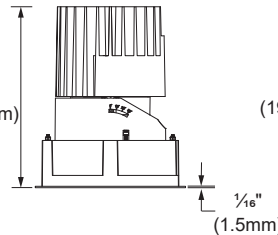

7 1/2"
(191mm)

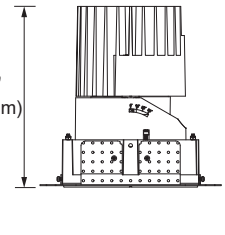

Ø 6 3/8"
(Ø 162mm)

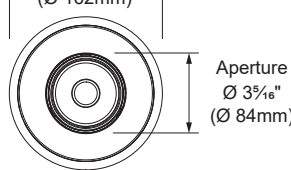

Aperture
Ø 3 3/8"
(Ø 84mm)

Ø 5 1/8"
(Ø 144mm)

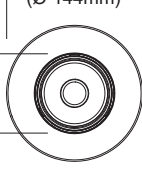

□ 6 1/4"
(□ 159mm)

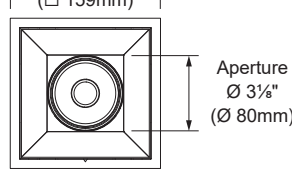

□ 5 1/2"
(□ 139mm)

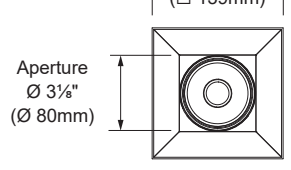

Wall Washer

Ø 6 3/8"
(Ø 162mm)

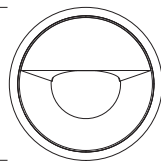

Ø 5 1/8"
(Ø 144mm)

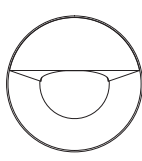

□ 6 1/4"
(□ 159mm)

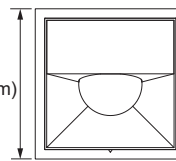

□ 5 1/2"
(□ 139mm)

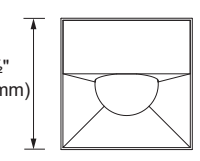

TRIMLESS MUD FRAME KIT

Trimless mud frame kit to be fastened to the gypsum board. The assembly is then finished by plastering, sanding and painting. Install the luminaire inside the opening once painting is completed. The kit is sold separately for retrofit installation or supplied with the plaster frame for new construction installation.

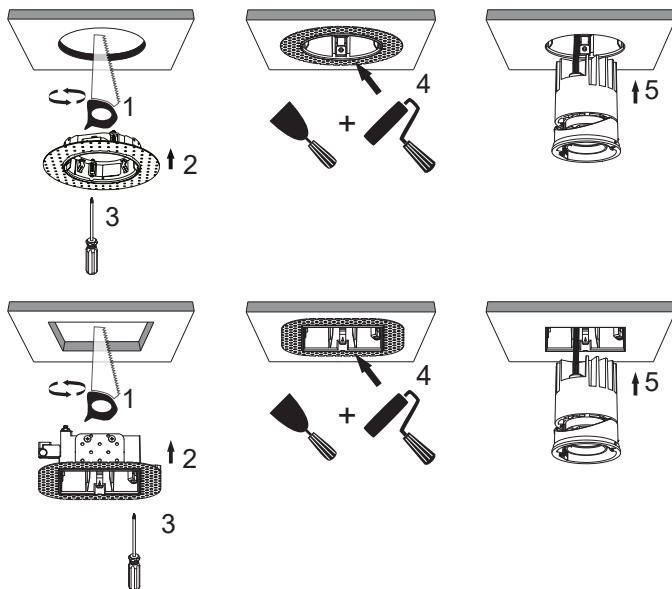

TRIMLESS MILLWORK FRAME KIT

Trimless millwork frame kit to be fastened to the ceiling. Install the luminaire inside the opening once the trimless millwork frame kit installation is completed. The kit is sold separately for retrofit installation or supplied with the plaster frame for new construction installation.

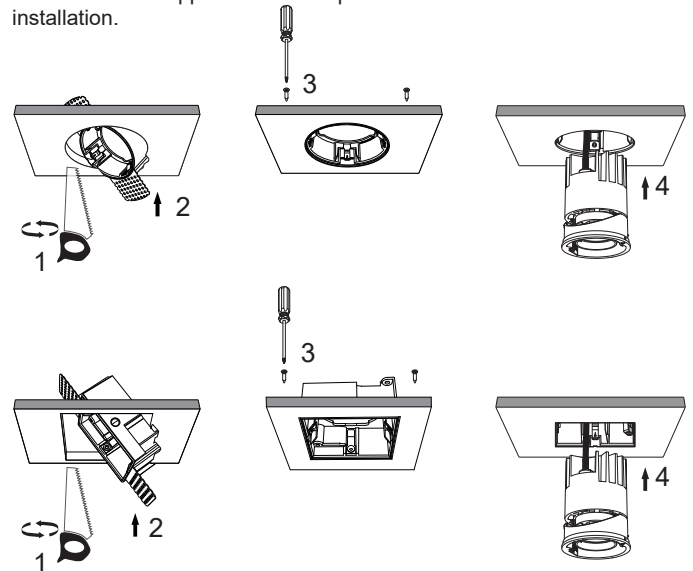

PHOTOMETRIC DATA ¹

Visit sistemalux.com for complete photometric data.

ADJUSTABLE



CCT (K)	CRI	SYSTEM POWER* (W)	OUTPUT (Nominal Luminous Flux)	OPTIC	LUMENS ² (lm)	EFFICACY (lm/w)	MAX CANDELA ² (cd)	MODELS (Round, Adjustable)
3000	90	41	46 (4600 lm)	Spot (25°)	4 258	104	19 559	LOGP6R-ASP
				Narrow Flood (30°)	4 598	112	16 153	LOGP6R-ANF
				Flood (40°)	4 677	114	9 423	LOGP6R-AFL
				Wide Flood (55°/50°)	4 485	109	5 738	LOGP6R-AWF

Use multiplier table for other CCT and CRI output data. Efficacy based on IESNA LM-79 test reports. Visit www.sistemalux.com for complete photometric data.

* System power corresponds to the maximum measured value considering the Power Factor. For Non-IC (**RF** and **NC** installations), the system power may increase by up to an additional 3W. Accordingly, the efficacy may vary depending on the resulting system power.

FIXED WALL WASHER



CCT (K)	CRI	SYSTEM POWER* (W)	OUTPUT (Nominal Luminous Flux)	OPTIC	LUMENS ³ (lm)	EFFICACY (lm/w)	MAX CANDELA ³ (cd)	MODELS (Round, Adjustable)
3000	90	41	28 (2800 lm)	Fixed Wall Washer	2 856	69	2 205	LOGP6R-FWW

Use multiplier table for other CCT and CRI output data. Efficacy based on IESNA LM-79 test reports. Visit www.sistemalux.com for complete photometric data.

* System power corresponds to the maximum measured value considering the Power Factor. For Non-IC (**RF** and **NC** installations), the system power may increase by up to an additional 3W. Accordingly, the efficacy may vary depending on the resulting system power.

*** USE MULTIPLIER TABLE FOR OTHER CCT OUTPUT DATA ¹**

CCT options	2700K	3000K	3500K	4000K
CRI options	90CRI	90CRI	90CRI	90CRI
Multiplier	0.96	1	1.01	1.03

*** USE MULTIPLIER TABLE FOR OTHER LUMEN OUTPUT DATA ¹**

Target lumen ⁴	3100 lm	3400 lm	3700 lm	4000 lm	4300 lm	4600 lm
Multiplier	0.69	0.74	0.8	0.86	0.92	1

*** USE MULTIPLIER TABLE FOR FIXED LUMEN OUTPUT DATA ¹**

Target Optic	LOGP6R-FSP	LOGP6R-FNF	LOGP6R-FFL	LOGP6R-FWF
Multiplier	0.91	0.91	0.89	0.91

⁽¹⁾ Please contact customer service for details.

⁽²⁾ Based on round (R) shape, trim (T) mounting and adjustable (A) optic.

⁽³⁾ Based on round (R) shape and trim (T) mounting.

⁽⁴⁾ Approximate lumen value, the fixture is configured to deliver under nominal conditions based on selected drive current.

* For the Square version, lumen output may differ from the Round version. Please refer to the IES files available on the website for detailed information.

LED COLOR FIDELITY DATA

COLOR VECTOR GRAPH

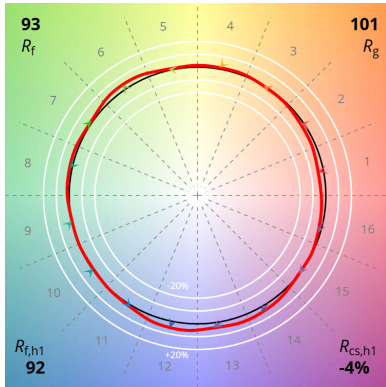

LOCAL COLOR FIDELITY

