



Reef is a range of short bollards with radial lighting emission obtained with a specific conical reflector. Perfect to illuminate with grazing lighting effects walking areas of residential, parks and public spaces, are available in three dimensions. The polycarbonate diffuser ensures a high impact resistance.

| | |
|-----------------------------------|--|
| Luminaire characteristics: | Power input: 9.8W to 36W Lumens: 197lm to 2 101lm (for 3000K, 90CRI) Luminaire efficacy: Up to 64lm/W |
| Source: | LED module (LM-80 tested) 2700K: 90CRI, 3000K: 90CRI, 4000K: 80CRI. |
| Lumen maintenance: | 80% of initial lumens at 70 000 hours (L80)(LM80). |
| Optics: | 2 x 90° / 180° / 360° |
| Material: | Body: Die-cast aluminum Lens: Clear polycarbonate Reflector: Aluminized polycarbonate Hardware: Stainless steel screws. |
| Mounting: | Fixing plate for ground installation |
| Electrical: | High efficiency electronic LED driver, rated at 50 000 hours, 120-277V. |
| Dimming: | 0-10V down to 10% (120-277V) |
| Finish: | Aluminum gray or anthracite gray (RAL7022) painted finish, following a double powder paint in 3 step process: surface treatment containing ceramic nano particles (Bonderite). Epoxy primer paint. Polyester powder paint with high resistance against UV rays and harsh weather conditions. |
| Weight: | Microreef 5.5lb (2.5kg) Minireef 13.7lb (6.2kg) Reef 26.9lb (12.2kg) |
| Warranty: | 5 year limited warranty. |
| Ratings: | IP65, IK10 |
| Certification: |  cULus listed for wet location |

ORDERING INFO

- UNV - - D10
FIXTURE



MODEL

MICROREEF

S5317- 360° **S5327**- 2X90° **S5337**- 180° **S5377**- 360°grid

MINIREEF

S5240- 360° **S5253**- 2x90° **S5263**- 180° **S5243**- 360° grid

REEF

S5247- 360° **S5257**- 2x90° **S5267**- 180° **S5297**- 360°grid

LED

H - 2700K, 90CRI **W** - 3000K, 90CRI **N** - 4000K, 80CRI

VOLTAGE

UNV - 120-277V

FINISH

14 - Aluminum gray **24** - Anthracite gray

DIMMING

D10 - 0-10V

ACCESSORIES

(TO BE ORDERED SEPARATELY)

S5301 - Flange for Microreef bollard with stainless steel screws Ø5 1/8" (130mm) x h: 6 1/8" (155mm)

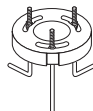

S5200 - Flange for Minireef bollard with stainless steel screws Ø7 1/2" (190mm) x h: 8 7/8" (225mm)

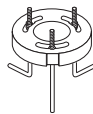

S5203 - Flange for Reef bollard with stainless steel screws Ø9 7/8" (250mm) x h: 8 7/8" (225mm)

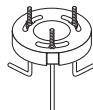

DIMENSIONS

MICROREEF
S5317 / S5327 / S5337 / S5377



TOP VIEW

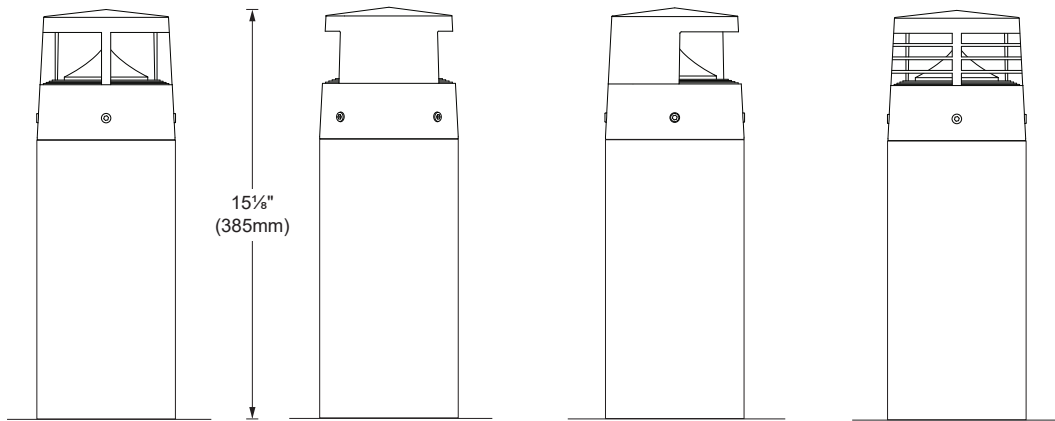

SIDE VIEW

DIMENSIONS

MINIREEF
S5240 / S5253 / S5263 / S5243

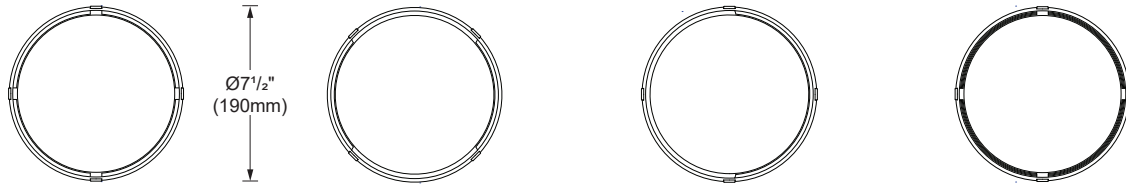

TOP VIEW

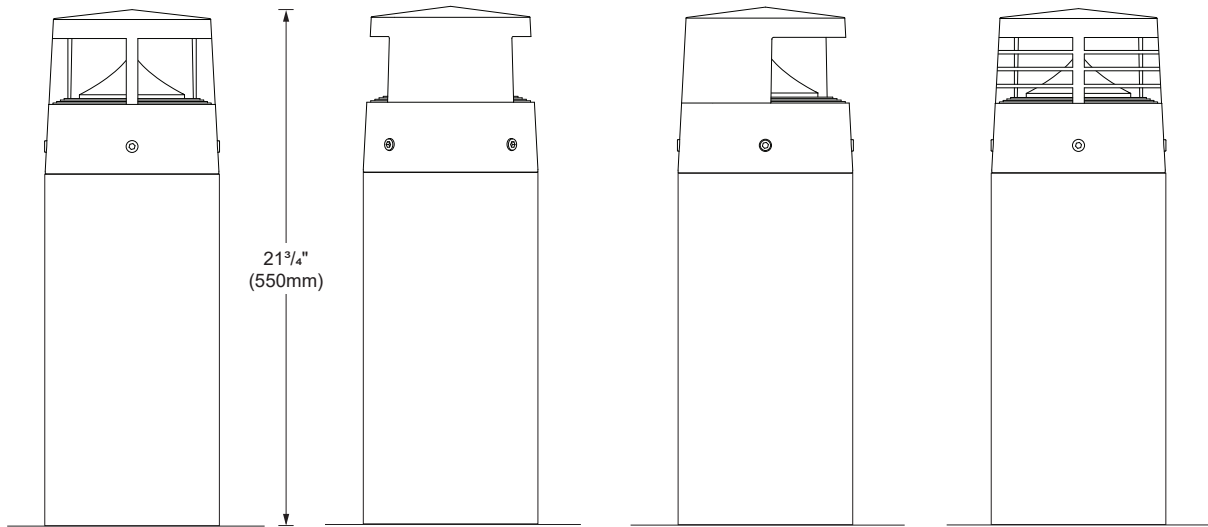

SIDE VIEW

DIMENSIONS

REEF
S5247 / S5257 / S5267 / S5297

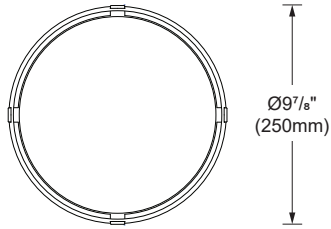

Ø9 7/8"
(250mm)

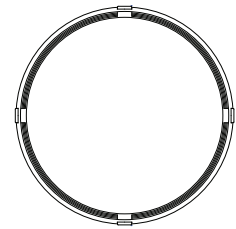
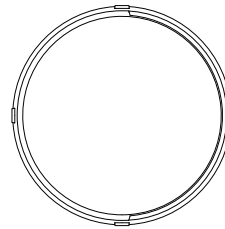
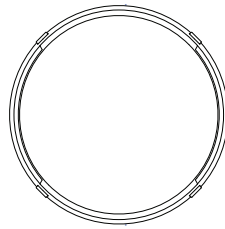

TOP VIEW

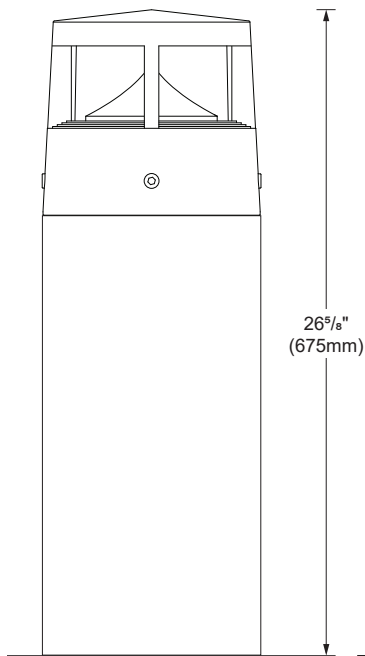

26 5/8"
(675mm)

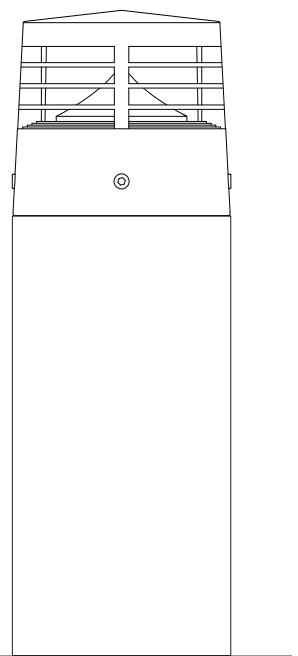
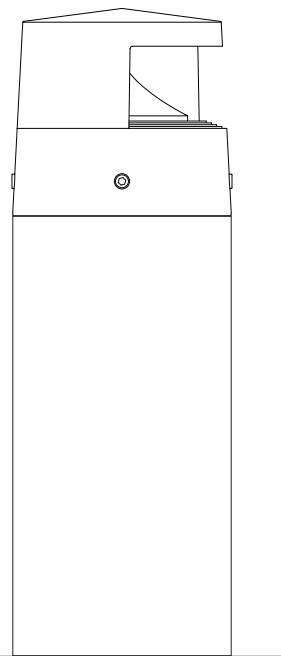
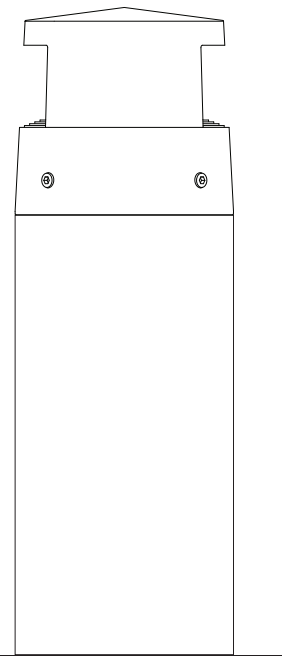

SIDE VIEW

PHOTOMETRIC DATA

Visit sistimalux.com for complete photometric data.

| CCT (K) | CRI | LOAD (W) | OPTIC | LUMENS (lm) | EFFICACY (lm / W) | MAX CANDELA (cd) | MODELS |
|---------|-----|----------|----------------|-------------|-------------------|------------------|--------|
| 3000K | 90 | 9.8W | 360° beam | 461 | 47 | 193 | S5317W |
| | | | 2x90° beam | 239 | 24 | 190 | S5327W |
| | | | 180° beam | 252 | 25 | 220 | S5337W |
| | | | 360° grid beam | 197 | 20 | 141 | S5377W |

360° beam (3000K, 90CRI)

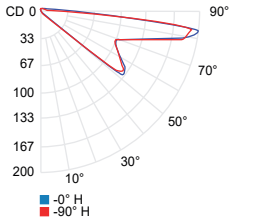

2x90° beam (3000K, 90CRI)

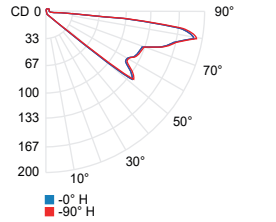

180° beam (3000K, 90CRI)

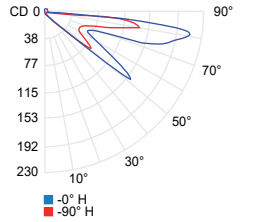

360° grid beam (3000K, 90CRI)

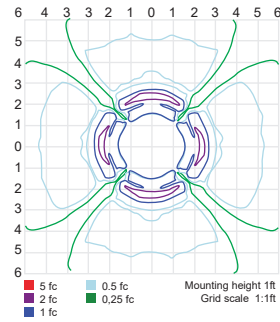
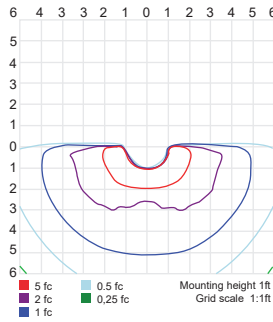
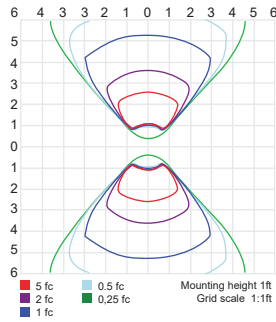
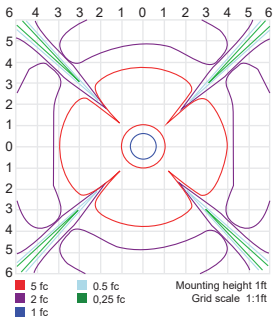
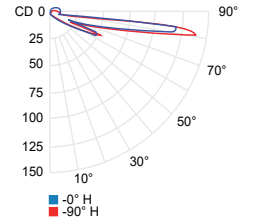

| | | | |
|-------------------|-------------|----------|-------------|
| CCT options | 2700K | 3000K | 4000K |
| CRI options | 90CRI | 90CRI | 80CRI |
| Multiplier | 0.94 | 1 | 1.26 |

PHOTOMETRIC DATA

Visit sistimalux.com for complete photometric data.

| CCT (K) | CRI | LOAD (W) | OPTIC | LUMENS (lm) | EFFICACY (lm / W) | MAX CANDELA (cd) | MODELS |
|---------|-----|----------|----------------|-------------|-------------------|------------------|--------|
| 3000K | 90 | 16.8W | 360° beam | 1091 | 64 | 466 | S5240W |
| | | | 2X 90° beam | 538 | 32 | 463 | S5253W |
| | | | 180° beam | 638 | 37 | 530 | S5263W |
| | | | 360° grid beam | 470 | 27 | 281 | S5243W |

360° beam (3000K, 90CRI)

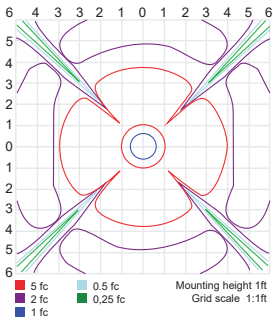
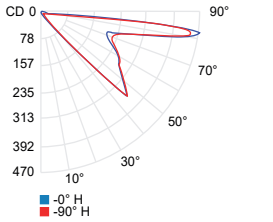

2x90° beam (3000K, 90CRI)

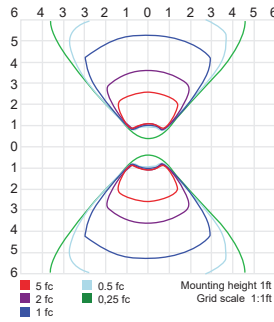
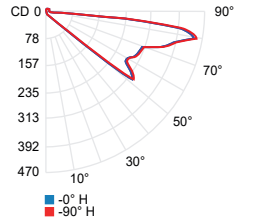

180° beam (3000K, 90CRI)

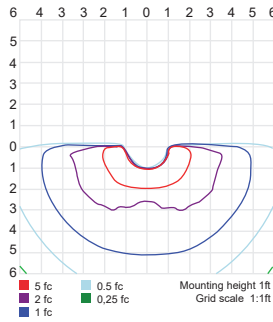
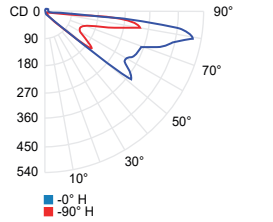

360° grid beam (3000K, 90CRI)

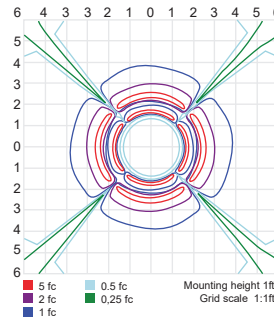
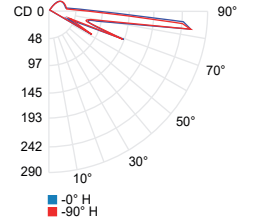

| | | | |
|-------------------|-------------|----------|-------------|
| CCT options | 2700K | 3000K | 4000K |
| CRI options | 90CRI | 90CRI | 80CRI |
| Multiplier | 0.94 | 1 | 1.26 |

PHOTOMETRIC DATA

Visit sistimalux.com for complete photometric data.

| CCT (K) | CRI | LOAD (W) | OPTIC | LUMENS (lm) | EFFICACY (lm / W) | MAX CANDELA (cd) | MODELS |
|---------|-----|----------|----------------|-------------|-------------------|------------------|--------|
| 3000K | 90 | 36W | 360° beam | 2 101 | 58 | 890 | S5247W |
| | | | 2x 90° beam | 927 | 35 | 826 | S5257W |
| | | | 180° beam | 1117 | 31 | 821 | S5267W |
| | | | 360° grid beam | 809 | 22 | 534 | S5297W |

360° beam (3000K, 90CRI)

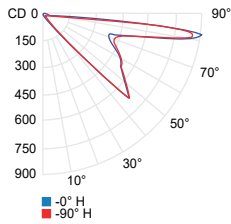

2x90° beam (3000K, 90CRI)

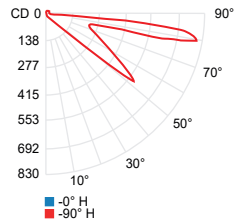

180° beam (3000K, 90CRI)

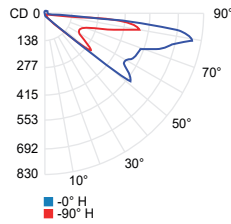

360° grid beam (3000K, 90CRI)

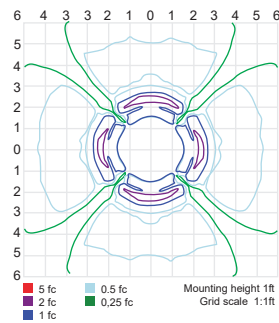
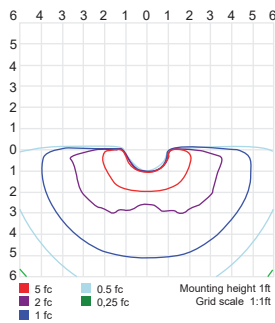
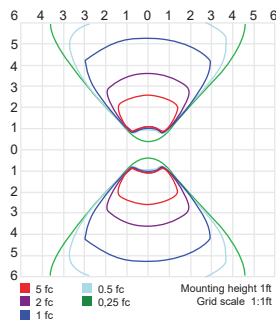
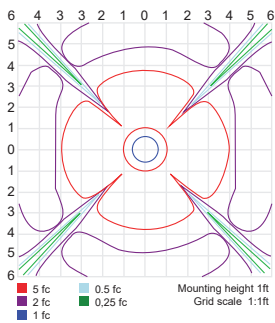
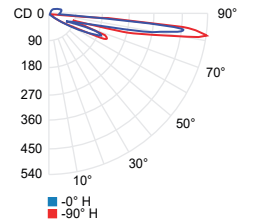

| | | | |
|-------------------|-------------|----------|-------------|
| CCT options | 2700K | 3000K | 4000K |
| CRI options | 90CRI | 90CRI | 80CRI |
| Multiplier | 0.94 | 1 | 1.26 |