



Elegant LED profile systems with small aperture, only 1.5". Modular continuous systems configured to obtain bespoke solutions by incorporating Laser Blade modules from iGuzzini.

**Luminaire characteristics:**

**Power input:** 12.6W to 36.6W per module  
**Lumens:** 336lm to 2583lm per module (3000K, >92CRI)  
**Luminaire efficacy:** Up to 70lm/W

**Source:**

White LED (LM-80)  
 2700K: 92CRI (90CRI min),  
 3000K: 92CRI (90CRI min),  
 3500K: 92CRI (90CRI min),  
 4000K: 92CRI (90CRI min).

**Lumen maintenance:**

80% of initial lumens at 50 000 hours (L80) (LM-79).

**Optics:**

Downlight: Spot, flood, wide flood, general light pro, medium oval transversal or longitudinal and wide flood oval transversal or longitudinal;  
 General light;  
 Wall washer or wall washer LGC.

**Material:**

Profile: Extruded aluminum,  
 Body and end caps: Die-cast aluminum,  
 Cover plate: Extruded aluminum,  
 Baffles and reflector: Thermoplastic,  
 Wall washer diffuser: PMMA ribbed acrylic.

**Mounting:**

Recessed trim installation (with flange) using included brackets for drywall, wood or other rigid ceiling panels. Not suitable for grid ceilings. Suitable for insulated ceilings. Maximum ceiling thickness of 1"(25mm). Custom linear patterns using 90°, "X" or "T" corners are available on request.

**Electrical:**

Integral high efficiency LED driver, rated at 50 000 hours, 120-277V.

**Dimming:**

0-10V (120-277V) or Lutron Hi-lume® 1% EcoSystem™ (120-277V), down to 1%.  
 Leading edge (TRIAC) and trailing edge (ELV) (120V only), down to 15%.

**Finish:**

Powder coated profile, cover plates (page 2).

**Weight:**

Max: 2.38lbs/ft (1.08kg/ft)

**Warranty:**

5 year limited warranty.

**Ratings:**

IP20

**Certification:**



cULus listed for damp location. Interior use only.

## ORDERING INFO

**3652** - - - - -

FIXTURE



### MODEL

**3652** - Recessed trim (with flange)

### LENGTH

The luminaire row must be ordered by 4' increments.

### CONFIGURATION

**A1** - 48" spacing       **A2** - 24" spacing

### LASER BLADE MODEL

**LB05** - 5 Cells<sup>(1)</sup>       **LB10** - 10 Cells       **LB15** - 15 Cells

### LED

**027** - 2700K, 92CRI\*       **030** - 3000K, 92CRI\*       **035** - 3500K, 92CRI\*       **040** - 4000K, 92CRI\*

### OPTIC

**SP** - Spot 13°       **FL** - Flood 32°       **WF** - Wide flood 47°       **GP** - General light pro       **LM** - Medium oval longitudinal<sup>(2)</sup>  
 **TM** - Medium oval transversal<sup>(2)</sup>       **LW** - Wide flood oval longitudinal<sup>(3)</sup>       **TW** - Wide flood oval transversal<sup>(3)</sup>       **GL** - General light       **WW** - Wall washer  
 **WL** - Wall washer LGC (longitudinal glare control)







### WALL WASHER DIRECTION (FEED POSITION)

**L** - Left feed       **R** - Right feed       **N** - Not applicable

### VOLTAGE

**UNV** - 120-277V       **120** - 120V

### FINISH (profile finish / cover plate finish / baffle finish)

**22** - Gray / black / black        **21** - White / black / black        **02** - Black / black / black   
 **10** - Gray / gray / black        **01** - White / white / black   
 **31** - White / white / white<sup>(4)</sup> 

### DIMMING

**D01** - 0-10V (down to 1%)<sup>(5)</sup>       **LTE** - Leading edge and trailing edge (120V only) (down to 15%)       **D2B** - Lutron Hi-Lume® 1% EcoSystem™, (down to 1%)<sup>(5)</sup>

\* 92CRI typical, minimum 90CRI.

<sup>(1)</sup> Available with 24" spacing (**A2**) configuration.

<sup>(2)</sup> Available with five (**LB05**) model.

<sup>(3)</sup> Available with five (**LB05**) and ten (**LB10**) laser blade models.

<sup>(4)</sup> Available for downlight (**SP**, **FL**, **LM**, **TM**, **LW**, **TW**, **WF**, **GP**) optics.

<sup>(5)</sup> Available with 120-277V (**UNV**) voltage.

**DIMENSION AND CONFIGURATION**

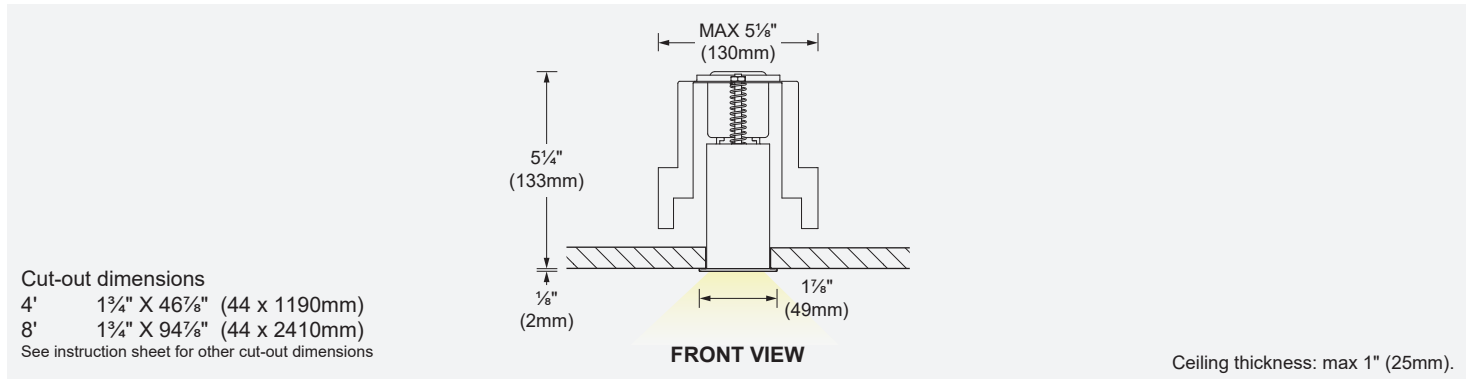

**INLINE UNIT CONFIGURATION WITH LASER BLADE 5 CELLS (LB05)**

Downlight, general light or wall washer

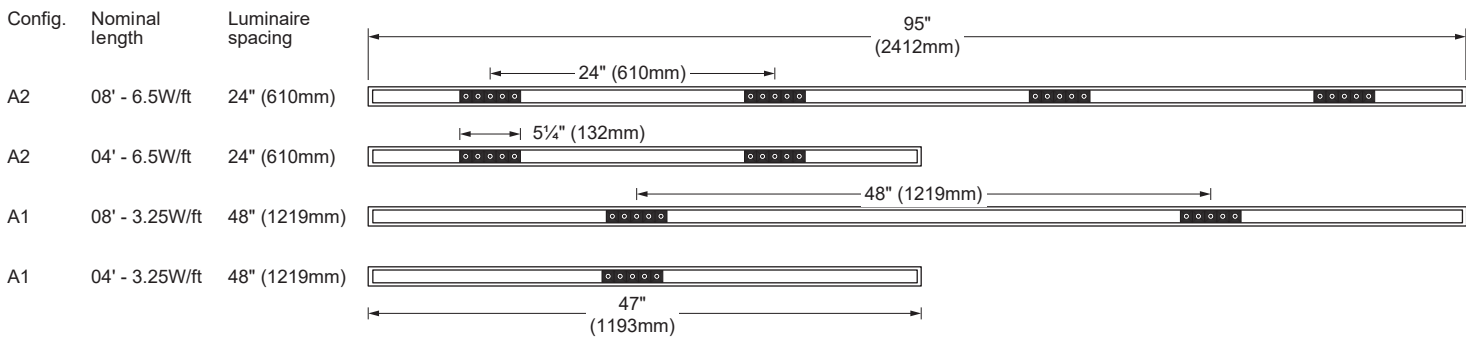

**INLINE UNIT CONFIGURATION WITH LASER BLADE 10 CELLS (LB10)**

Downlight, general light or wall washer

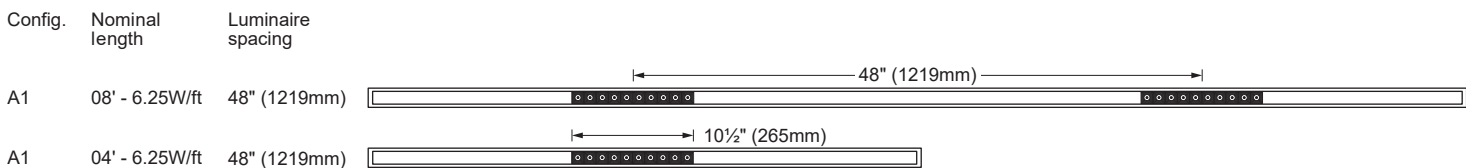

**INLINE UNIT CONFIGURATION WITH LASER BLADE 15 CELLS (LB15)**

Downlight, general light or wall washer

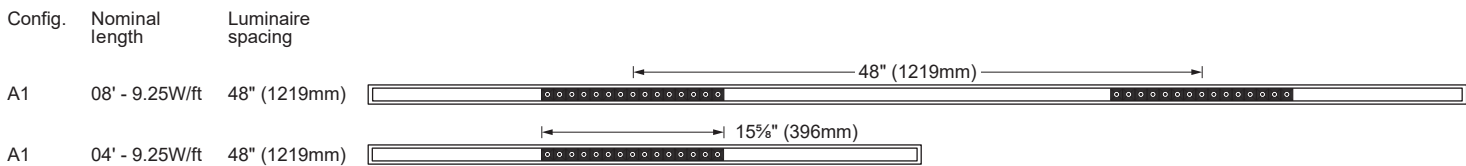

**CONTINUOUS ROW EXAMPLE**

Inline units can be combined to obtain a linear continuous row.

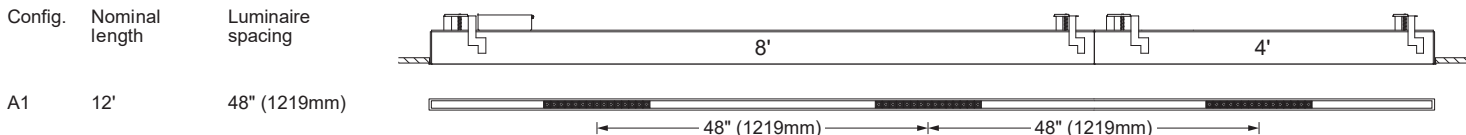

**LED COLOR FIDELITY DATA**

CCT	R1	R2	R3	R4	R5	R6	R7	R8	R9	R10	R11	R12	R13	R14	R15	Rf	Rg	Melanopic ratio
2700K	92	96	98	91	91	95	91	79	55	89	92	86	93	98	88	91	100	0.488
3000K	93	97	98	92	93	95	92	82	60	91	92	82	94	99	90	92	99	0.571
3500K	92	95	96	92	91	93	93	83	59	87	92	79	93	97	89	92	99	0.635
4000K	93	94	94	93	92	91	94	86	64	85	93	78	93	96	90	91	100	0.715

**OVAL BEAM DISTRIBUTION**

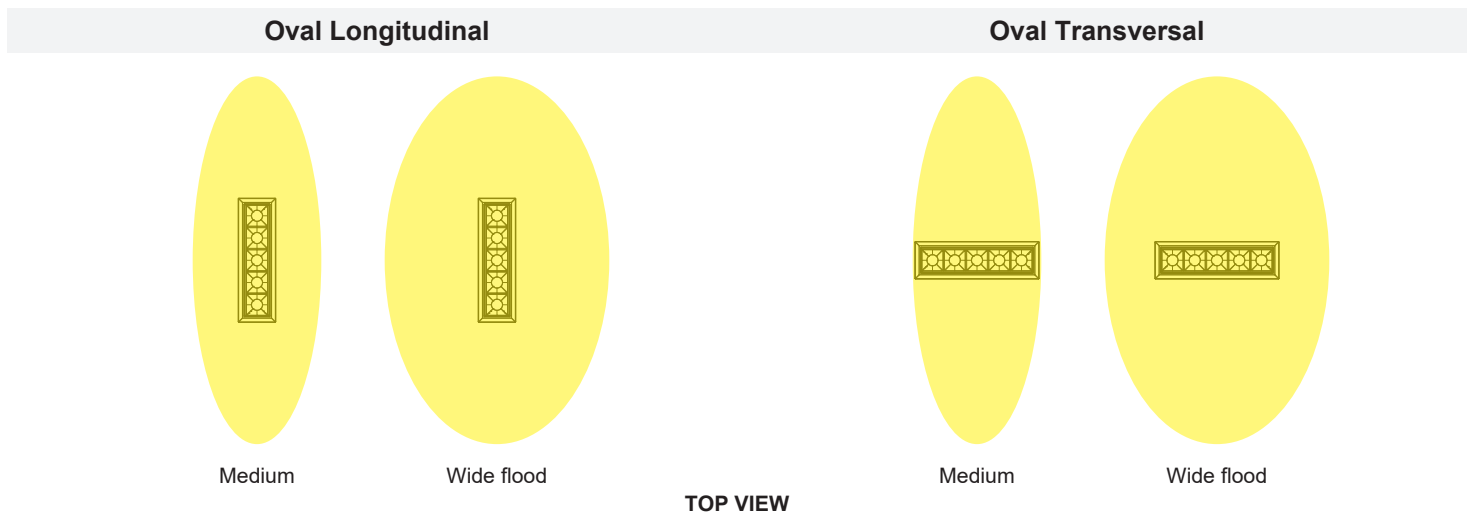

**WALL WASHER DIRECTION (FEED POSITION)**

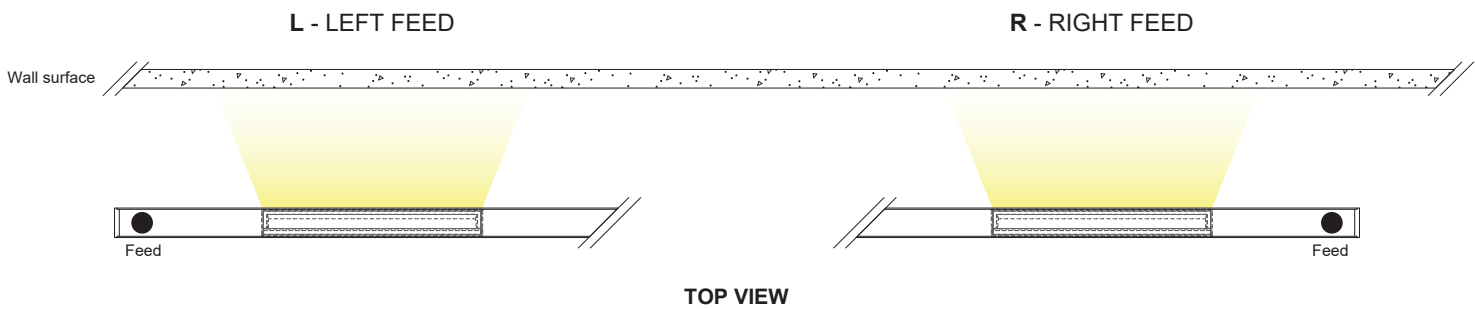

**PHOTOMETRIC DATA**

\*Photometric data for one laser blade module

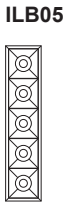

CCT (K)	CRI	LOAD (W)	OPTIC	LUMENS (lm)	EFFICACY (lm / W)	MAX CANDELA (cd)	MODELS
3000K	92	12.6W	Spot 13°	861	68	8 250	ILB05-030-SP
			Flood 32°	851	67	2 857	ILB05-030-FL
			Wide flood 47°	851	67	1 628	ILB05-030-WF
			General light pro	788	62	1 122	ILB05-030-GP
			Medium oval longitudinal	767	60	1 281	ILB05-030-LM
			Medium oval transversal	746	59	1 221	ILB05-030-TM
			Wide flood oval longitudinal	756	60	722	ILB05-030-LW
			Wide flood oval transversal	746	59	718	ILB05-030-TW

Use multiplier table for other CCT and CRI output data. Efficacy based on IESNA LM-79 test reports. Visit [iguzzini.com/us](http://iguzzini.com/us) for complete photometric data.

Spot 13° (3000K, 92CRI)

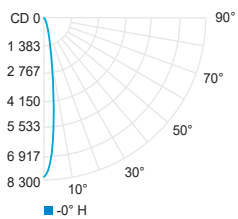

Center beam fc	Beam width ft
2ft 2 063	0.5
4ft 516	0.9
6ft 229	1.4
8ft 129	1.9
10ft 82.5	2.3
12ft 57.3	2.8

Flood 32° (3000K, 92CRI)

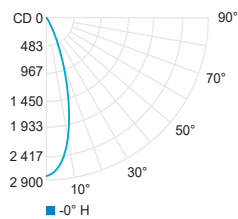

Center beam fc	Beam width ft
2ft 714	1.1
4ft 179	2.3
6ft 79.4	3.4
8ft 44.6	4.5
10ft 28.6	5.6
12ft 19.8	6.8

Wide flood 47° (3000K, 92CRI)

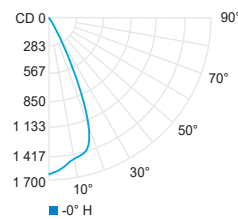

Center beam fc	Beam width ft
2ft 407	1.7
4ft 102	3.5
6ft 45.2	5.2
8ft 25.4	7.0
10ft 16.3	8.7
12ft 11.3	10.4

General light pro (3000K, 92CRI)

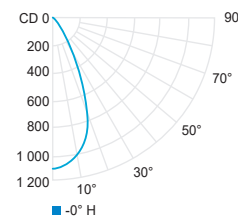

Center beam fc	Beam width ft
2ft 281	1.8
4ft 70.1	3.5
6ft 31.2	5.3
8ft 17.5	7.0
10ft 11.2	8.8
12ft 7.79	10.6

Medium oval long. (3000K, 92CRI)

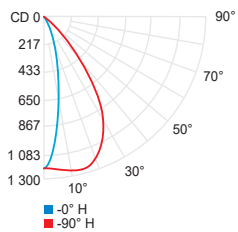

Center beam fc	Beam width ft
2ft 307	0.8 3.0
4ft 76.8	1.5 6.0
6ft 34.1	2.3 9.1
8ft 19.2	3.0 12.1
10ft 12.3	3.8 15.1
12ft 8.53	4.6 18.1

Medium oval tran. (3000K, 92CRI)

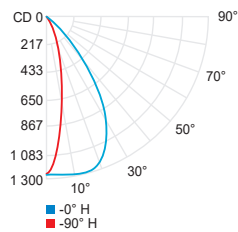

Center beam fc	Beam width ft
2ft 298	3.0 0.8
4ft 74.5	6.0 1.5
6ft 33.1	9.0 2.3
8ft 18.6	12.0 3.1
10ft 11.9	15.0 3.9
12ft 8.28	18.0 4.6

Wide flood oval long. (3000K, 92CRI)

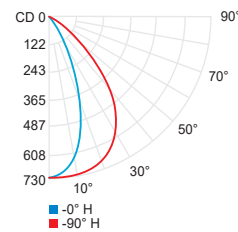

Center beam fc	Beam width ft
2ft 180	1.5 3.5
4ft 45.0	3.1 7.1
6ft 20.0	4.6 10.6
8ft 11.2	6.2 14.2
10ft 7.19	7.7 17.7
12ft 5.00	9.3 21.2

Wide flood oval tran. (3000K, 92CRI)

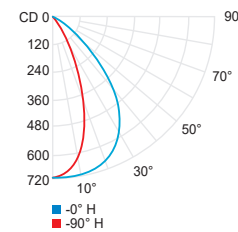

Center beam fc	Beam width ft
2ft 179	3.5 1.5
4ft 44.7	7.0 3.0
6ft 19.9	10.5 4.5
8ft 11.2	14.0 6.0
10ft 7.16	17.5 7.6
12ft 4.97	21.0 9.1

CCT options	2700K	3000K	3500K	4000K
CRI options	92CRI	92CRI	92CRI	92CRI
Multiplier	<b>0.95</b>	<b>1</b>	<b>1.05</b>	<b>1.10</b>

**PHOTOMETRIC DATA**

**LB05**

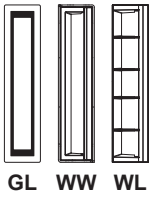

\*Photometric data for one laser blade module

CCT (K)	CRI	LOAD (W)	OPTIC	LUMENS (lm)	EFFICACY (lm / W)	MAX CANDELA (cd)	MODELS
3000K	92	12.6W	General light	620	49	511	LB05-030-GL
			Wall washer	420	22	338	LB05-030-WW
			Wall washer LGC (Longitudinal Glare Control)	336	26	325	LB05-030-WL

Use multiplier table for other CCT and CRI output data. Efficacy based on IESNA LM-79 test reports. Visit [sistimalux.com](http://sistimalux.com) for complete photometric data.

General light (3000K, 92CRI)

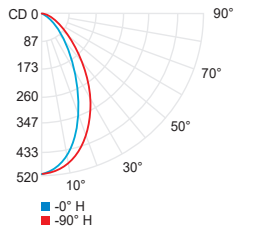

Wall washer (3000K, 92CRI)

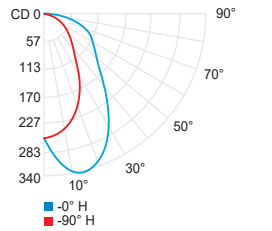

Wall washer LGC (3000K, 92CRI)

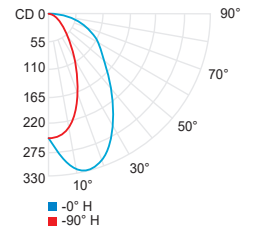

	Center beam fc	Beam width ft	
2ft	128	2.0	2.9
4ft	31.9	4.0	5.7
6ft	14.2	6.0	8.6
8ft	7.98	8.0	11.4
10ft	5.11	10.0	14.3
12ft	3.55	12.0	17.2

CCT options	2700K	3000K	3500K	4000K
CRI options	92CRI	92CRI	92CRI	92CRI
<b>Multiplier</b>	<b>0.95</b>	<b>1</b>	<b>1.05</b>	<b>1.10</b>

**PHOTOMETRIC DATA**

\*Photometric data for one laser blade module

**ILB10**

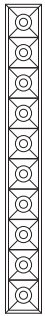

CCT (K)	CRI	LOAD (W)	OPTIC	LUMENS (lm)	EFFICACY (lm / W)	MAX CANDELA (cd)	MODELS
3000K	92	24.7W	Spot 13°	1 681	68	16 108	ILB10-030-SP
			Flood 32°	1 661	67	5 578	ILB10-030-FL
			Wide flood 47°	1 661	67	3 179	ILB10-030-WF
			General light pro	1 538	62	2 191	ILB10-030-GP
			Wide flood oval longitudinal	1 476	59	1 410	ILB10-030-LW
			Wide flood oval transversal	1 456	58	1 402	ILB10-030-TW

Use multiplier table for other CCT and CRI output data. Efficacy based on IESNA LM-79 test reports. Visit [iguzzini.com/us](http://iguzzini.com/us) for complete photometric data.

Spot 13° (3000K, 92CRI)

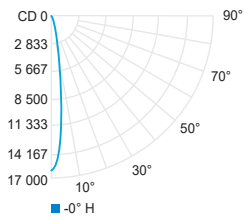

Center beam fc	Beam width ft
2ft	4 027 0.5
4ft	1 007 0.9
6ft	447 1.4
8ft	252 1.9
10ft	161 2.3
12ft	112 2.8

Flood 32° (3000K, 92CRI)

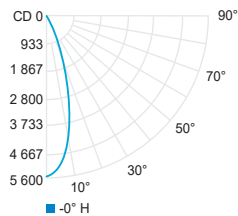

Center beam fc	Beam width ft
2ft	1 395 1.1
4ft	349 2.3
6ft	155 3.4
8ft	87.2 4.5
10ft	55.8 5.6
12ft	38.7 6.8

Wide flood 47° (3000K, 92CRI)

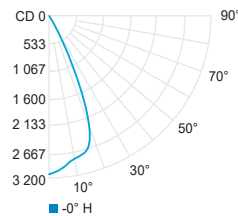

Center beam fc	Beam width ft
2ft	714 1.8
4ft	179 3.5
6ft	73.9 5.3
8ft	44.6 7.0
10ft	28.6 8.8
12ft	19.8 10.6

General light pro (3000K, 92CRI)

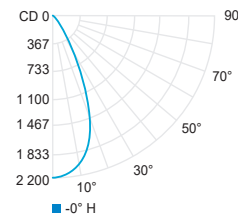

Center beam fc	Beam width ft
2ft	548 1.8
4ft	137 3.5
6ft	60.9 5.3
8ft	34.2 7.0
10ft	21.9 8.8
12ft	15.2 10.6

Wide flood oval long. (3000K, 92CRI)

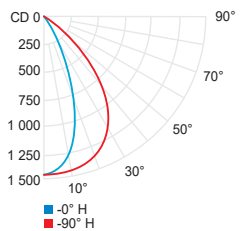

Center beam fc	Beam width ft
2ft	351 1.6 3.5
4ft	87.8 3.1 7.1
6ft	39.0 4.7 10.6
8ft	21.9 6.2 14.2
10ft	14.0 7.8 17.7
12ft	9.75 9.3 21.2

Wide flood oval tran. (3000K, 92CRI)

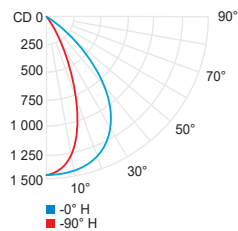

Center beam fc	Beam width ft
2ft	349 3.5 1.5
4ft	87.3 7.0 3.0
6ft	38.8 10.5 4.5
8ft	21.8 14.0 6.0
10ft	14.0 17.5 7.6
12ft	9.70 21.0 9.1

CCT options	2700K	3000K	3500K	4000K
CRI options	92CRI	92CRI	92CRI	92CRI
<b>Multiplier</b>	<b>0.95</b>	<b>1</b>	<b>1.05</b>	<b>1.10</b>

## PHOTOMETRIC DATA

### LB10

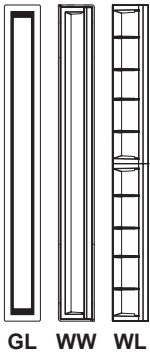

\*Photometric data for one laser blade module

CCT (K)	CRI	LOAD (W)	OPTIC	LUMENS (lm)	EFFICACY (lm / W)	MAX CANDELA (cd)	MODELS
3000K	92	24.7W	General light	1 210	48	999	LB10-030-GL
			Wall washer	820	33	661	LB10-030-WW
			Wall washer LGC (Longitudinal Glare Control)	656	26	636	LB10-030-WL

Use multiplier table for other CCT and CRI output data. Efficacy based on IESNA LM-79 test reports. Visit [sistimalux.com](http://sistimalux.com) for complete photometric data.

General light (3000K, 92CRI)

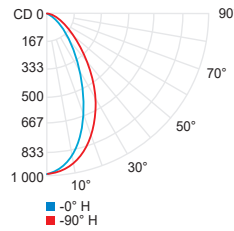

Wall washer (3000K, 92CRI)

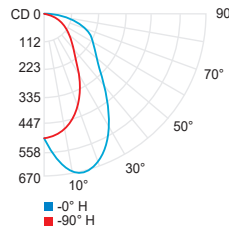

Wall washer LGC (3000K, 92CRI)

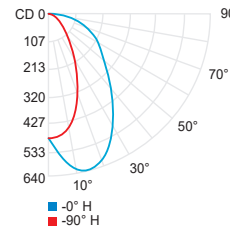

Center beam fc	Beam width ft	
2ft	249	2.0 2.9
4ft	62.4	4.0 5.7
6ft	27.7	6.0 8.6
8ft	15.6	8.0 11.4
10ft	9.98	10.0 14.3
12ft	6.93	12.0 17.1

CCT options	2700K	3000K	3500K	4000K
CRI options	92CRI	92CRI	92CRI	92CRI
<b>Multiplier</b>	<b>0.95</b>	<b>1</b>	<b>1.05</b>	<b>1.10</b>



**PHOTOMETRIC DATA**

\*Photometric data for one laser blade module

**LB15**

CCT (K)	CRI	LOAD (W)	OPTIC	LUMENS (lm)	EFFICACY (lm / W)	MAX CANDELA (cd)	MODELS
3000K	92	36.6W	Spot 13°	2 583	70	24 751	LB15-030-SP
			Flood 32°	2 552	69	8 571	LB15-030-FL
			Wide flood 47°	2 552	69	4 885	LB15-030-WF
			General light pro	2 363	64	3 367	LB15-030-GP

Use multiplier table for other CCT and CRI output data. Efficacy based on IESNA LM-79 test reports. Visit [iguzzini.com/us](http://iguzzini.com/us) for complete photometric data.

Spot 13° (3000K, 92CRI)

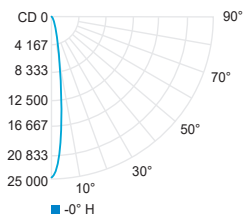

	Center beam fc	Beam width ft
2ft	6 188	0.5
4ft	1 547	0.9
6ft	688	1.4
8ft	387	1.9
10ft	248	2.3
12ft	172	2.8

Flood 32° (3000K, 92CRI)

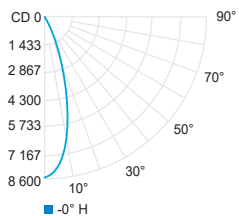

	Center beam fc	Beam width ft
2ft	2 143	1.1
4ft	536	2.3
6ft	238	3.4
8ft	134	4.5
10ft	85.7	5.6
12ft	59.5	6.8

Wide flood 47° (3000K, 92CRI)

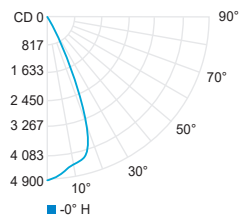

	Center beam fc	Beam width ft
2ft	1 221	1.7
4ft	305	3.5
6ft	136	5.2
8ft	76.3	7.0
10ft	48.9	8.7
12ft	33.9	10.4

General light pro (3000K, 92CRI)

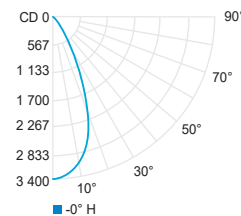

	Center beam fc	Beam width ft
2ft	842	1.8
4ft	210	3.5
6ft	93.5	5.3
8ft	52.6	7.0
10ft	33.7	8.8
12ft	23.4	10.6

CCT options	2700K	3000K	3500K	4000K
CRI options	92CRI	92CRI	92CRI	92CRI
<b>Multiplier</b>	<b>0.95</b>	<b>1</b>	<b>1.05</b>	<b>1.10</b>

## PHOTOMETRIC DATA

LB15

\*Photometric data for one laser blade module

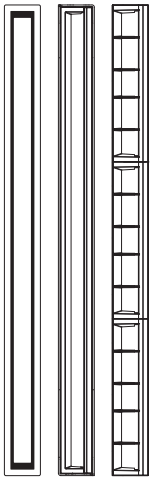

GL WW WL

CCT (K)	CRI	LOAD (W)	OPTIC	LUMENS (lm)	EFFICACY (lm / W)	MAX CANDELA (cd)	MODELS
3000K	92	36.6W	General light	1 859	50	1 536	LB15-030-GL
			Wall washer	1 260	34	1 017	LB15-030-WW
			Wall washer LGC (Longitudinal Glare Control)	1 008	27	977	LB15-030-WL

Use multiplier table for other CCT and CRI output data. Efficacy based on IESNA LM-79 test reports. Visit [sistimalux.com](http://sistimalux.com) for complete photometric data.

General light (3000K, 92CRI)

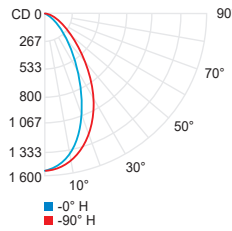

Wall washer (3000K, 92CRI)

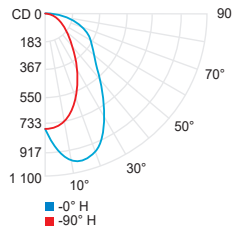

Wall washer LGC (3000K, 92CRI)

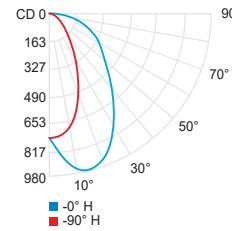

Center beam fc	Beam width ft	
2ft	383	2.0 2.9
4ft	95.8	4.0 5.7
6ft	42.6	6.0 8.6
8ft	24.0	8.0 11.4
10ft	15.3	10.0 14.3
12ft	10.6	12.0 17.1

CCT options	2700K	3000K	3500K	4000K
CRI options	92CRI	92CRI	92CRI	92CRI
<b>Multiplier</b>	<b>0.95</b>	<b>1</b>	<b>1.05</b>	<b>1.10</b>