



Collection of bollards for commercial and institutional application, the KUBE is an object of urban design that can be integrated into any context and is particularly suitable for paths, parks and landscape areas. Exceptional European build quality with high corrosion resistant finish. Robust marine grade die-cast aluminum construction, with stainless steel fasteners and factory sealed glass diffuser.

<b>Luminaire characteristics:</b>	Power input system: 45W Lumens system for 3000K, 90CRI: 1099lm to 1425 lm Luminaire efficacy for 3000K: Up to 32lm/W
<b>Source:</b>	White LED (LM-80 tested) 2700K: 90CRI, 3000K: 90CRI, 4000K: 80CRI.
<b>Lumen maintenance:</b>	80% of initial lumens at 70 000 hours (L80 B10) T77°F (25°C) 80% of initial lumens at 50 000 hours (L80 B10) T104°F (40°C)
<b>Optics:</b>	Accent light
<b>Material:</b>	Body: Die-cast and extruded aluminum Diffuser: Toughened glass. Hardware: Stainless steel screws and silicone gaskets
<b>Mounting:</b>	Install with flange accessory or fasten to ground
<b>Electrical:</b>	High efficiency electronic LED driver, rated 50 000 hours, 120V-277V. Overvoltage protection: 6kV
<b>Dimming:</b>	0-10V (120-277V), down to 15%
<b>Finish:</b>	Aluminum gray, black and white painted finish. Double powder paint in 3 step process: surface treatment containing ceramic nano particles (Bonderite). Epoxy primer paint. Polyester powder paint with high resistance against UV rays and harsh weather conditions.
<b>Weight:</b>	S6340 14.83lb (6.73 kg) S6346 21.38lb (9.7kg) S6347 44.02lb (19.97 kg)
<b>Warranty:</b>	 5 year limited warranty.
<b>Ratings:</b>	IP54, IK06.
<b>Certification:</b>	cULus listed for wet location

**ORDERING INFO**

**- UNV - - D10**

FIXTURE



**MODELS**

**S6340** - Kube 240

**S6346** - Kube 580

**S6347** - Kube 1350

**LED**

**H** - 2700K, 90CRI

**W** - 3000K, 90CRI

**N** - 4000K, 80CRI

**VOLTAGE**

**UNV** - 120-277V

**FINISH**

**01** - White

**09** - Black

**14** - Aluminum gray

**DIMMING**

**D10** - 0-10V

**ACCESSORIES**

(TO BE ORDERED SEPARATELY)

**S3554** - Black Stake (For S6340 only)  
H: 16½" (420mm)  
(The upper 3½"(89mm) must stay out of the ground)



**S5350** - Flange with stainless steel screws  
Ø 9¾" x H 9¾"  
(238mm x H: 232mm)  
(To be installed in concrete)

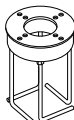

**DIMENSIONS**

**S6340**  
Kube 240 mm

**S6346**  
Kube 580 mm

**S6347**  
Kube 580 mm

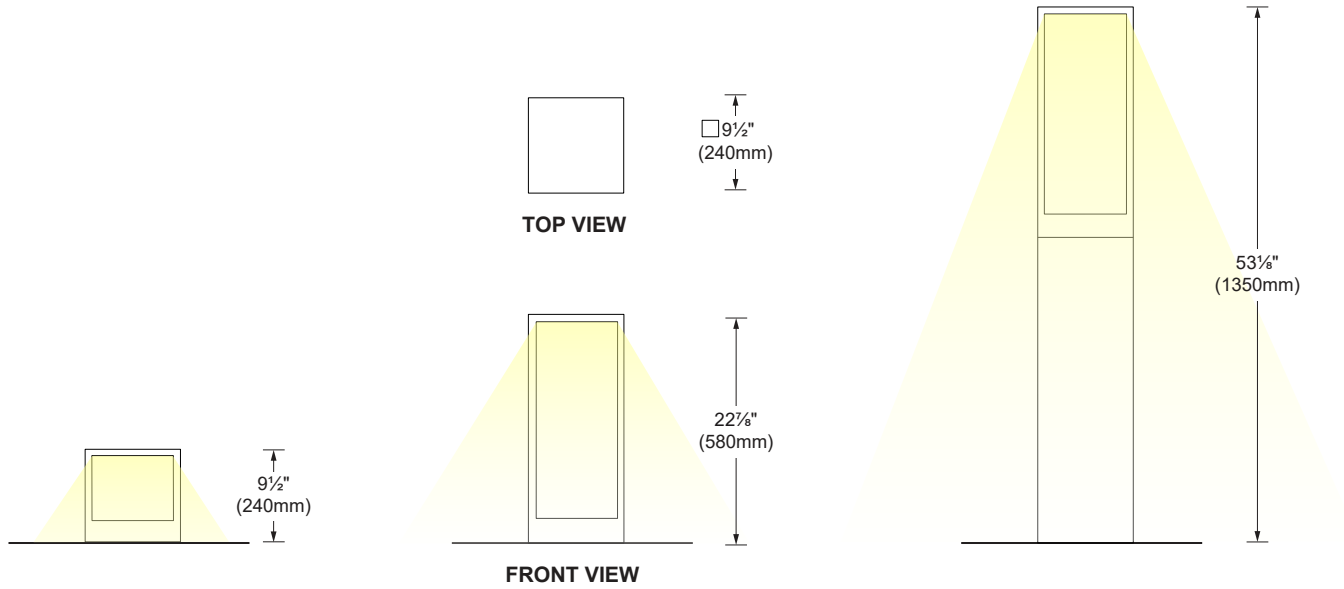

**PHOTOMETRIC DATA**

Visit [sistimalux.com](http://sistimalux.com) for complete photometric data.

CCT (K)	CRI	LOAD (W)	OPTIC	LUMENS (lm)	EFFICACY (lm / W)	MAX CANDELA (cd)	MODELS
3000K	90	45W	Accent light	1100	24	429	S6340W - 240 mm
				1425	32	764	S6346W - 580 mm
				1425	32	764	S6347W - 1350 mm

Accent light 3000K,90CRI - 240

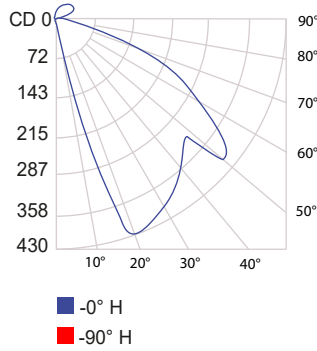

Accent light 3000K,90CRI - 580

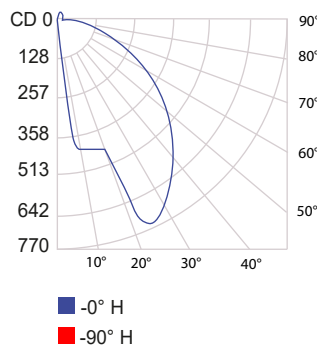

Accent light 3000K,90CRI - 1350

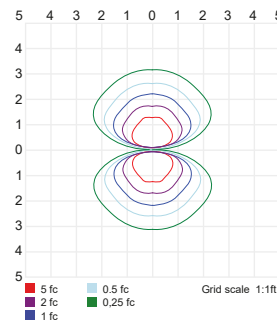
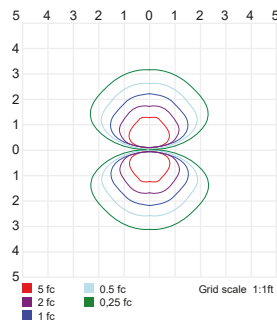
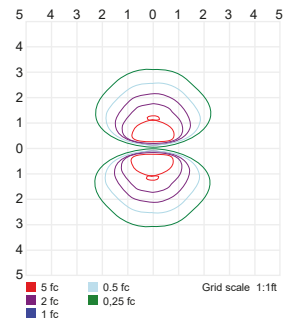
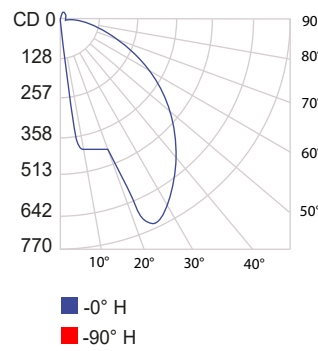

CCT options	2700K	3000K	4000K
CRI options	90CRI	90CRI	80CRI
<b>Multiplier</b>	<b>0.94</b>	<b>1</b>	<b>1.08</b>