

Small aperture downlight for architectural applications, 3" with trim. The entire luminaire body is made of one piece die-cast aluminum, yielding maximum thermal performance to maintain the light output and color consistency during the life of the product. Excellent build quality for the most demanding applications.



Luminaire characteristic:

MODELS	POWER* (W/ft)	OPTIC	LUMEN (lm/ft)	EFFICACY (lm/W)	MAX CANDELA (cd)
V68-B-930-SP	14W	Spot 19°	1 052	75	6 918
V68-B-930-FL		Flood 40°	1 059	75	2 643
V68-B-930-WW		Wall washer	601	42	372
V68-H-930-SP	20W	Spot 19°	1 505	75	9 896
V68-H-930-FL		Flood 40°	1 514	75	3 779
V68-H-930-WW		Wall washer	860	43	532

* System power corresponds to the maximum measured value considering the Power Factor. For Non-IC (RF and NC installations), the system power (W) may increase by up to an additional 2W. Accordingly, the efficacy may vary depending on the resulting system power.

Power input: 14W or 20W
Lumens: 760lm to 1900lm (for 3000K, 90CRI)
Luminaire efficacy: Up to 95lm/W

Source:	COB LED module (LM-80) 2700K : 90CRI, 3000K : 90CRI, 3500K : 90CRI,
Lumen maintenance:	80% of initial lumens at 100 000 hours (L80) (LM-79).
Optic:	Spot, flood and wall washer optics.
Material:	Body: Die-cast aluminum optical assembly Reflector: Metalized polycarbonate Baffle: Painted polycarbonate
Mounting:	Remodel, new construction with plaster frame, new construction with housing for insulated ceiling, chicago plenum and airtight. (page 3-4)
Electrical:	Integral high efficiency LED driver rated at 50 000 hours, 120V or 277V.
Dimming:	0-10V dimming (120V or 277V), down to 10% or leading (TRIAC) and trailing edge (ELV) dimming (120V only), down to 5%.
Finish:	Powder coated body and baffle (page 2).
Weight:	2.7lbs (1.22kg).
Warranty:	5 year limited warranty.
Rating:	IP20

Certification: cULus listed for damp location. Interior use only.



 Title 24-JA8-2019 high efficiency luminaire. Airtight luminaire less than 2 cfm leakage @1.57PSI per ASTM E283. To confirm which versions are certified, please consult the product list: <https://cacertappliances.energy.ca.gov/Pages/Search/AdvancedSearch.aspx>

Energy star certified product. To confirm which versions are certified, please consult the product list: www.energystar.gov/productfinder

ORDERING INFO

V68 - - - - -
FIXTURE

- V68 --
HOUSING

MODEL

V68 - Fixed

INSTALLATION

- RF** - Remodeling (No housing)
 NC - new construction plaster frame
 IC - Insulated ceiling housing
 CP - Chicago plenum housing
 AT - Airtight housing

OUTPUT

- B** - Base output
 H - High output

LED

- 927** - 2700K, 90 CRI
 930 - 3000K, 90 CRI
 935 - 3500K, 90 CRI

OPTIC

- SP** - Spot (19°)
 FL - Flood (40°)
 WW - Wall Washer

VOLTAGE

- 120** - 120V
 277 - 277V

FINISH (trim finish / baffle finish)

- | | White Trim | Black Trim |
|------------------------------|--|---|
| White baffle | <input type="checkbox"/> 01 - White / white ⁽¹⁾ | <input type="checkbox"/> 23 - Black / white ⁽¹⁾ |
| Black baffle | <input type="checkbox"/> 21 - White / black ⁽¹⁾ | <input type="checkbox"/> 02 - Black / black ⁽¹⁾ |
| Matte anodized baffle | <input type="checkbox"/> 13 - White / matte anodized ⁽²⁾ | <input type="checkbox"/> 33 - Black / matte anodized |

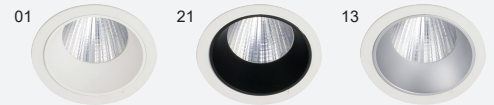

DIMMING

- LTE** - Leading and trailing edge dimming (down to 5%)(120V only)⁽³⁾
 D10 - 0-10V (down to 10%)

⁽¹⁾ Available for spot (SP) and flood (FL) optics.
⁽²⁾ May require a longer lead time than standard (except for wall washer optic). Please contact customer service for details.
⁽³⁾ Daisy chain connections possible.

INSTALLATION ACCESSORIES
(TO BE ORDERED SEPARATELY)

- BI-696-KIT** - Hanger bars extension kit.
 For spaces from 29¼" to 48½"

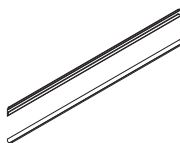

INSTALLATION OPTIONS

Remodel (RF)

For existing ceiling structure. Suitable for non-insulated ceiling assemblies, like sheetrock, or paneling. Fixture is ready for remodeling installation.

Ceiling thickness: 1/8" - 1 3/8" (3 - 35mm)

Total weight: 2.7lbs (1.22kg)

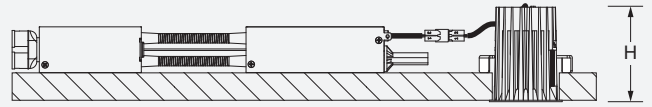

Model	Cut-out dimensions	Clearance (H)
V68	Ø 2 3/4" (Ø 68mm)	5 1/2" (140mm)

*Can be installed from below the ceiling.

New construction with plaster frame (NC)

Plaster frame with hanger bars system to be installed during rough-in phase. Suitable for non-insulated ceiling assemblies, like sheetrock, or paneling. Plaster frame and trim can be shipped separately.

Ceiling thickness: 1/8" - 1 3/8" (3 - 35mm)

Total weight: 3.9lbs (1.77kg)

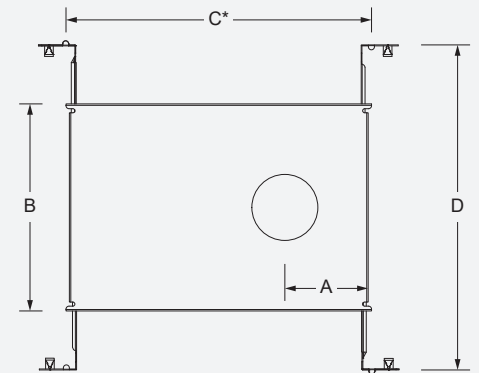
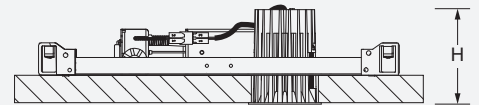

*Provide a minimum of 1 1/8" (46mm) on each side for the hanger bar fixations

Model	Plaster frame	Cut-out dimensions	Cut-out position (A)	Overall dimensions (BxC)	Hanger bars (D)	Clearance (H)
V68	BN-V68-NC	Ø 2 3/4" (Ø 68mm)	4" (101mm)	8 5/8" x 15 5/8" (219 x 397mm)	14 1/4" to 26" (362 to 660mm)	5 1/2" (140mm)

INSTALLATION OPTIONS

New construction with housing suitable for insulated ceiling (IC), chicago plenum (CP) or airtight (AT).

Housing with hanger bars system for new construction installations.
Suitable for insulated ceiling ,chicago plenum or airtight applications.
Housing can be shipped separately.

Ceiling thickness: 1/8" - 1 3/8" (3 - 35mm)

Total weight:

IC/CP: 7.47lbs (3.39kg)

AT: 10.8lb (4.90kg)

Certification: Airtight housing (AT) certified less than 2 cfm leakage @ 1.57PSI per ASTM E283.

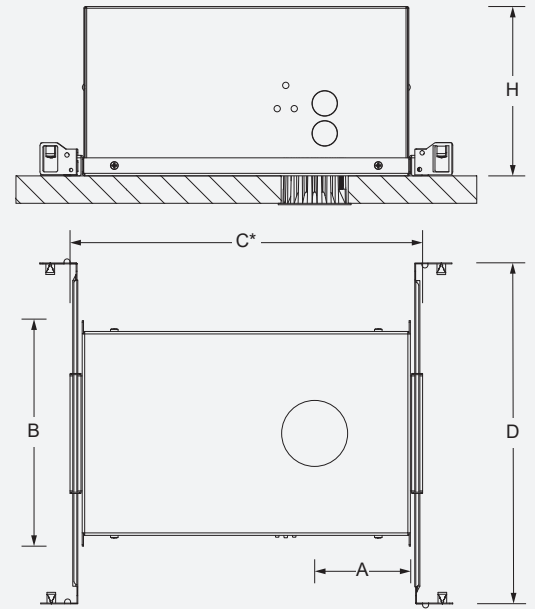

*Provide a minimum of 1 7/8" (46mm) on each side for the hanger bar fixations

Model	Housing	Cut-out dimensions	Cut-out position (A)	Overall dimensions (BxC)	Hanger bars (D)	Clearance (H)
V68	BI-V68-IC/CP-XXX	Ø 2 3/4" (Ø 68mm)	4" (101mm)	10 7/16" x 14 13/16" (239 x 373mm)	15" to 26" (381 to 660mm)	7 1/4" (183mm)
	BI-V68-AT-XXX					

DIMENSIONS

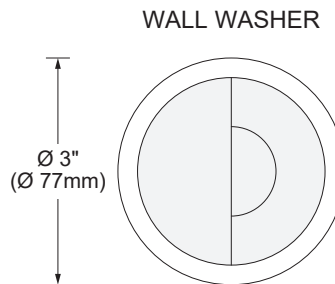
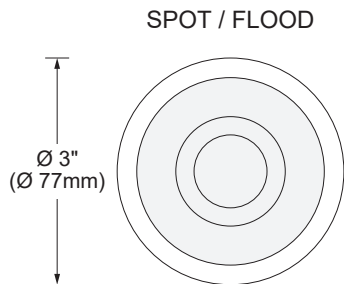

LED COLOR FIDELITY DATA

CRI	CCT	R1	R2	R3	R4	R5	R6	R7	R8	R9	R10	R11	R12	R13	R14	R15	Rf	Rg	Melanopic ratio
90	2700K	94	98	99	94	95	98	91	82	61	95	96	88	96	99	-	93	99	0.497
	3000K	94	97	99	94	94	96	93	83	62	92	95	84	95	99	-	93	99	0.563
	3500K	93	96	98	93	93	95	93	84	62	90	94	78	94	98	-	92	98	0.642

PHOTOMETRIC DATA

CCT (K)	CRI	OUTPUT	POWER* (W)	OPTIC	LUMENS (lm)	EFFICACY (lm / W)	MAX CANDELA (cd)	MODELS
3000K	90	BO	14W	Spot 19°	1 052	75	6 918	V68-B-930-SP
				Flood 40°	1 059	75	2 643	V68-B-930-FL
				Wall washer	601	42	372	V68-B-930-WW
		HO	20W	Spot 19°	1 505	75	9 896	V68-H-930-SP
				Flood 40°	1 514	75	3 779	V68-H-930-FL
				Wall washer	860	43	532	V68-H-930-WW

* System power corresponds to the maximum measured value considering the Power Factor. For Non-IC (RF and NC installations), the system power may increase by up to an additional 2W. Accordingly, the efficacy may vary depending on the resulting system power.

Spot 19° BO (3000K, 90CRI)

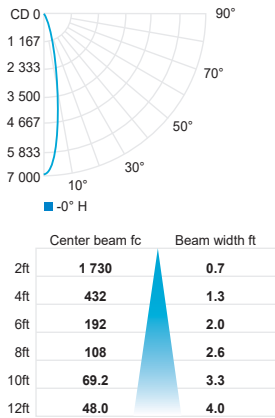

Flood 40° BO (3000K, 90CRI)

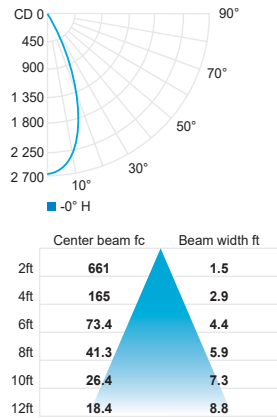

Wall washer (3000K, 90CRI)

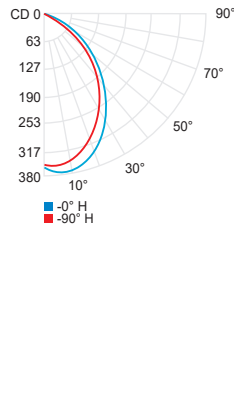

CCT options	2700K	3000K	3500K
CRI options	90CRI	90CRI	90CRI
Multiplier	0.95	1	1.05