

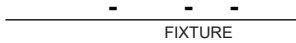

Ground mounted bollard suitable for walkways and paths, being a valid alternative to a wall mounted illumination

<b>Luminaire characteristics:</b>	<b>Power input:</b> 7W, 12.5W or 26W <b>Lumens:</b> 204 to 1133lm (for 3000K, 90CRI) <b>Luminaire efficacy:</b> Up to 48lm/W
<b>Source:</b>	LED module (LM-80 tested) 2700K: 90CRI, 3000K: 90CRI, 4000K: 80CRI.
<b>Lumen maintenance:</b>	80% of initial lumens at 70 000 hours(L80)
<b>Optics:</b>	Accent light.
<b>Material:</b>	Body: Die-cast aluminum Diffuser: Clear tempered glass. Methacrylate concentrating lens combined with a narrow beam shutter is used to achieve a blade of light effect. Hardware: Stainless steel screws and silicone gaskets
<b>Electrical:</b>	Universal high efficiency electronic LED driver rated at 50 000 hours, 120-277V.
<b>Dimming:</b>	Optional 0-10V (120-277V), down to 15%.
<b>Mounting:</b>	Install with flange accessory or fasten to ground.
<b>Finish:</b>	White, black and aluminum gray.
<b>weight:</b>	S7285 15lb (6.8kg) S7286 9.04lb (4.1kg) S7287 4.21lb (1.91kg)
<b>Warranty:</b>	5 year limited warranty.
<b>Ratings:</b>	IP54, IK06
<b>Certification:</b>	 cULus listed for wet location

## ORDERING INFO



### MODEL

- S7285** - Cool square bollard       **S7286** - Minicool square bollard       **S7287** - Microcool square bollard

### LED

- H** - 2700K, 90CRI       **W** - 3000K, 90CRI       **N** - 4000K, 80CRI

### VOLTAGE

- 120** - 120V       **UNV** - 120-277V

### FINISH

- 01** - White       **09** - Black       **14** - Aluminum

### DIMMING

- ND** - No dimming       **D10** - 0- 10V

## ACCESSORIES

(TO BE ORDERED SEPARATELY)

- S7284** - Flange for Microcool square bollard with stainless steel screws  
7<sup>1</sup>/<sub>4</sub>" x 6<sup>1</sup>/<sub>2</sub>" (187mm x 167mm)
- S7288** - Flange for Minicool square bollard with stainless steel screws  
10<sup>3</sup>/<sub>4</sub>" x 9<sup>7</sup>/<sub>8</sub>" (272mm x 251mm)
- S7289** - Flange for Cool square bollard with stainless steel screws  
13<sup>1</sup>/<sub>4</sub>" x 9<sup>1</sup>/<sub>8</sub>" (333mm x 250mm)



## DIMENSIONS

**Microcool square bollard**  
S7287

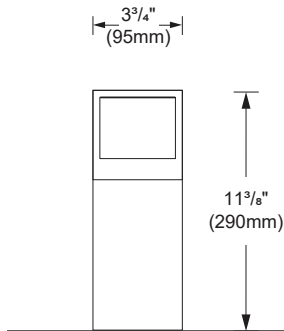

**Minicool square bollard**  
S7286



**TOP VIEW**

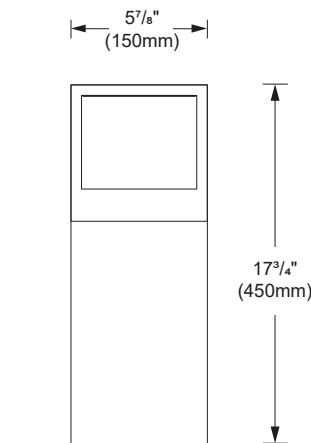

**FRONT VIEW**

**Cool square bollard**  
S7285

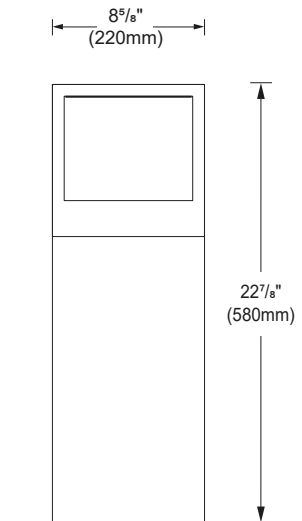

## PHOTOMETRIC DATA

Visit [sistimalux.com](http://sistimalux.com) for complete photometric data.

CCT (K)	CRI	LOAD (W)	OPTIC	LUMENS (lm)	EFFICACY (lm / W)	MAX CANDELA (cd)	MODELS
3000K	90	7W	Accent light	204	29	105	S7287W

Accent light (3000K, 90 CRI)

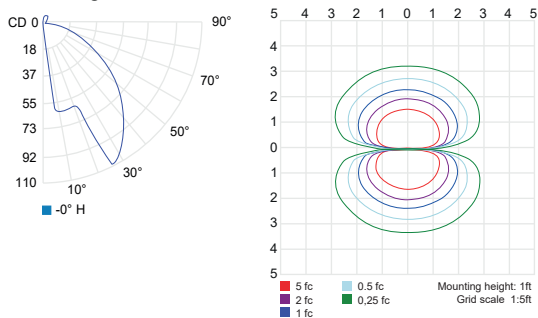

CCT (K)	CRI	LOAD (W)	OPTIC	LUMENS (lm)	EFFICACY (lm / W)	MAX CANDELA (cd)	MODELS
3000K	90	12.5W	Accent light	482	38	240	S7286W

Accent light (3000K, 90 CRI)

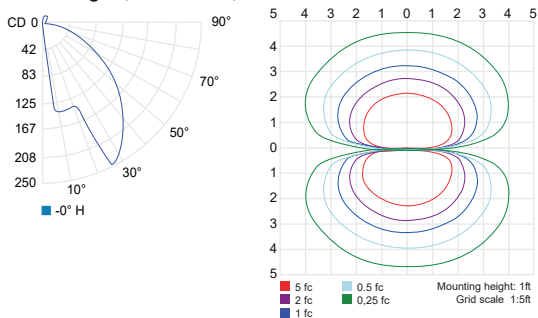

CCT (K)	CRI	LOAD (W)	OPTIC	LUMENS (lm)	EFFICACY (lm / W)	MAX CANDELA (cd)	MODELS
3000K	90	26W	Accent light	1133	48	560	S7285W

Accent light (3000K, 90 CRI)

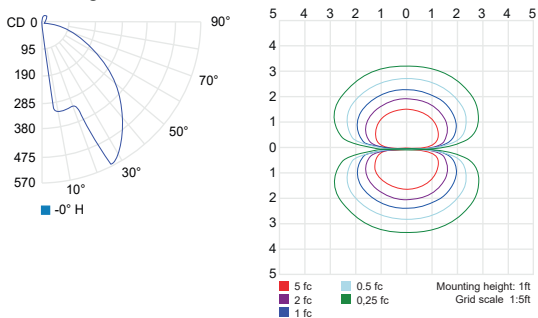

CCT options	2700K	3000K	4000K
CRI options	90CRI	90CRI	80CRI
<b>Multiplier</b>	<b>0.94</b>	<b>1</b>	<b>1.12</b>