

Elegant LED profile system with small aperture, only 1¼". Modular continuous systems configured to obtain bespoke solutions by incorporating Laser Blade XS modules from iGuzzini. Available as single modules or continuous runs.

Luminaire characteristics:

Power input: 13.5W to 34.5W per module
Lumens: 291lm to 2241lm per module (3000K, 90CRI)
Luminaire efficacy: Up to 64lm/W

Source: White LED (LM-80)
2700K: 90CRI,
3000K: 90CRI,
3500K: 90CRI,
4000K: 90CRI.

Lumen maintenance: 80% of initial lumens at 50 000 hours (L80) (LM-79).

Optics: Medium, flood, wide flood, wall washer or wall washer LGC.

Material: Profile: Extruded aluminum,
Body and end caps: Die-cast aluminum,
Cover plate: Extruded aluminum,
Baffles and reflector: Thermoplastic,
Wall washer diffuser: PMMA ribbed acrylic.

Mounting: Recessed trim installation (with flange) using included brackets for drywall, wood or other rigid ceiling panels. Not suitable for grid ceilings. Suitable for insulated ceilings. Maximum ceiling thickness of 1"(25mm). Custom linear patterns using 90°, "X" or "T" corners are available on request.

Electrical: Integral high efficiency LED driver, rated at 50 000 hours, 120-277V.

Dimming: 0-10V (120-277V), down to 1%. Leading edge (TRIAC) and trailing edge (ELV) (120V only), down to 10%.

Finish: Available in white RAL9010 or black RAL9004.

Weight: Max: 1.19 lbs/ft (0.54kg/ft)

Warranty: 5 year limited warranty.

Ratings: IP20

Certification:  cULus listed for damp location. Interior use only.

Powered by **iGuzzini**

ORDERING INFO

3452 - - - -
FIXTURE



MODEL

3452 - Recessed trim (with flange)

LENGTH

04 - 4' Long **08** - 8' Long

CONFIGURATION

C2 - 2 modules **C3** - 3 modules⁽¹⁾ **C5** - 5 modules⁽¹⁾

LASER BLADE MODEL

LBXS05 - 5 Cells **LBXS10** - 10 Cells⁽²⁾ **LBXS15** - 15 Cells⁽³⁾

LED

927 - 2700K, 90CRI **930** - 3000K, 90CRI **935** - 3500K, 90CRI **940** - 4000K, 90CRI

DIRECT OPTIC

MD - Medium 24° **FL** - Flood 41° **WF** - Wide flood 58° **WW** - Wall washer **WL** - Wall washer LGC (longitudinal glare control)



WALL WASHER DIRECTION (FEED POSITION)

L - Left feed **R** - Right feed **N** - Not applicable⁽⁴⁾

VOLTAGE

UNV - 120-277V **120** - 120V

FINISH (Profile finish / Cover plate finish / Baffle finish)

21 - White / Black / Black  **02** - Black / Black / Black 
 01 - White / White / Black 

DIMMING

D01 - 0-10V (down to 1%)⁽⁵⁾ **LTE** - Leading and trailing edge (120V only) (down to 10%)

⁽¹⁾ Available for 8' long (**08**) length.
⁽²⁾ Available with 2 (**C2**) or 3 (**C3**) modules configurations.
⁽³⁾ Available with 2 (**C2**) module configuration.
⁽⁴⁾ Available for medium (**MD**), flood (**FL**), wide flood (**WF**) optics.
⁽⁵⁾ Available with 120-277V (**UNV**) voltage.

WALL WASHER DIRECTION (FEED POSITION)

L - LEFT FEED

R - RIGHT FEED

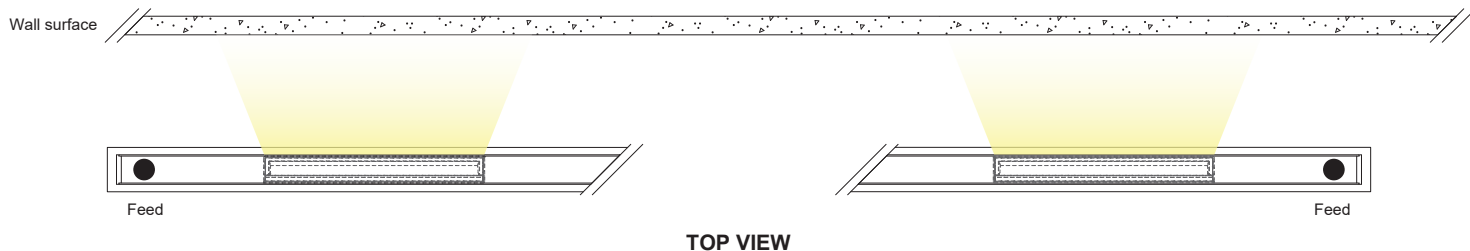

FAMILY OVERVIEW

Linear small family offers a wide range of mounting and optic options for multiple applications

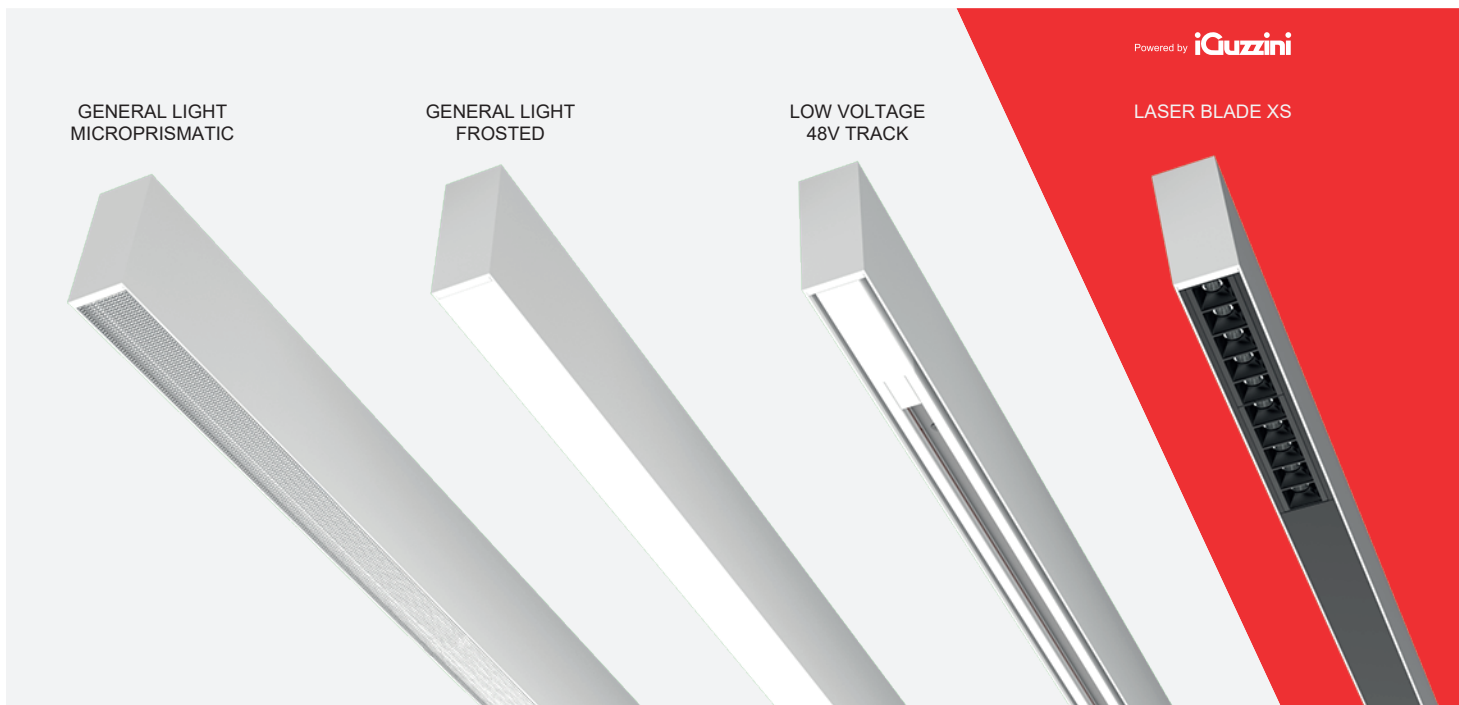

DIMENSIONS

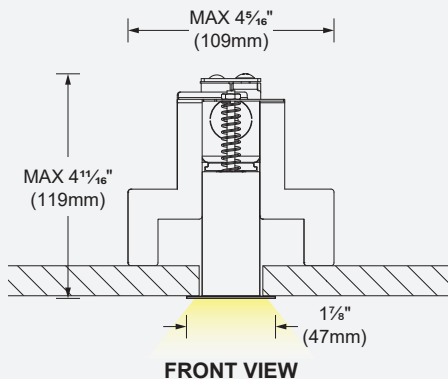

Cut-out dimensions

- 4' 1 3/8" X 48 3/8" (35 x 1227mm)
- 8' 1 3/8" X 96 1/4" (35 x 2444mm)

*Trim height: 1/8" (2mm)
Ceiling thickness: max 1" (25mm)

SOLO UNIT CONFIGURATION WITH LASER BLADE XS 5 CELLS (LBXS05)

Downlight or wall washer

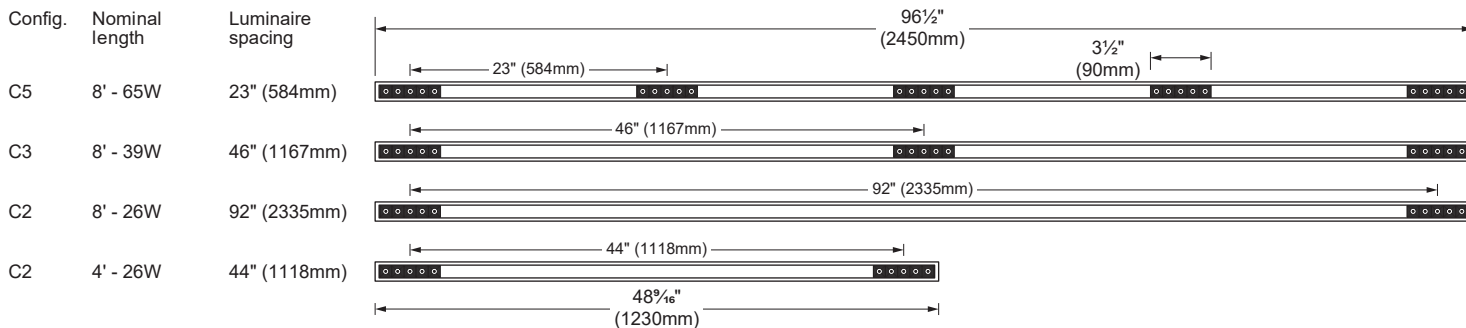

SOLO UNIT CONFIGURATION WITH LASER BLADE XS 10 CELLS (LBXS10)

Downlight or wall washer

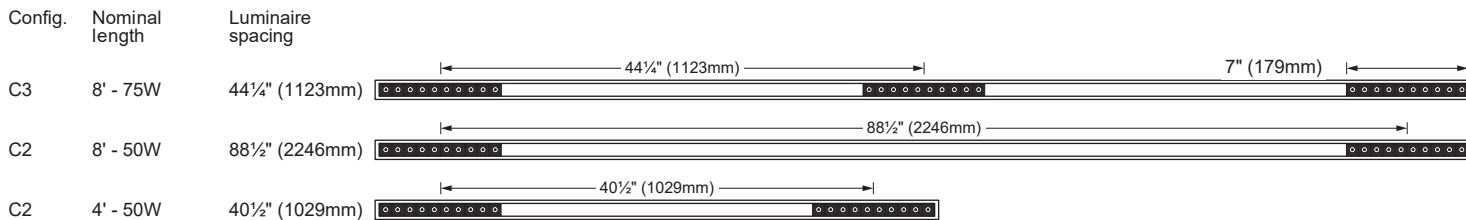

SOLO UNIT CONFIGURATION WITH LASER BLADE XS 15 CELLS (LBXS15)

Downlight or wall washer



LED COLOR FIDELITY DATA

CCT	R1	R2	R3	R4	R5	R6	R7	R8	R9	R10	R11	R12	R13	R14	R15	Rf	Rg	Melanopic ratio
2700K	94	94	91	93	93	92	93	88	70	84	94	82	94	94	92	88	104	0.456
3000K	97	96	93	94	96	94	95	92	82	89	94	86	97	95	96	90	104	0.538
3500K	99	99	98	98	98	97	97	96	93	99	99	83	99	98	98	92	99	0.666
4000K	94	94	93	94	92	91	97	91	74	85	91	72	93	96	92	91	99	0.744

PHOTOMETRIC DATA

Photometric data for one laser blade module

LBXS05

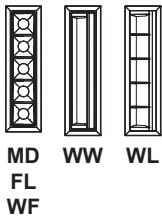

CCT (K)	CRI	LOAD (W)	OPTIC	LUMENS (lm)	EFFICACY (lm / W)	MAX CANDELA (cd)	MODELS
3000K	90	13.5W	Medium 24°	695	51	3 212	LBXS05-930-MD
			Flood 41°	730	54	1 500	LBXS05-930-FL
			Wide flood 58°	730	54	930	LBXS05-930-WF
			Wall washer	345	25	259	LBXS05-930-WW
			Wall washer LGC (longitudinal glare control)	291	21	287	LBXS05-930-WL

Use multiplier table for other CCT and CRI output data. Efficacy based on IESNA LM-79 test reports. Visit iguzzini.com/us for complete photometric data.

Medium 24° (3000K, 90CRI)

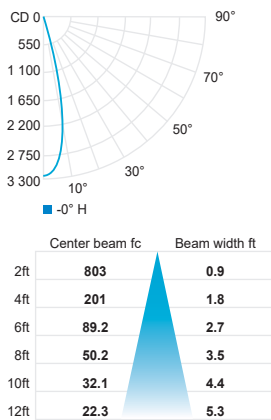

Flood 41° (3000K, 90CRI)

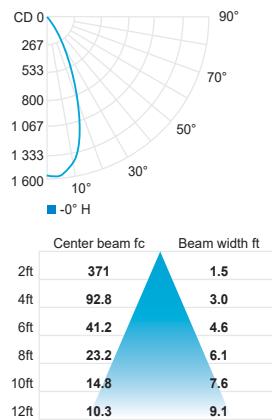

Wide flood 58° (3000K, 90CRI)

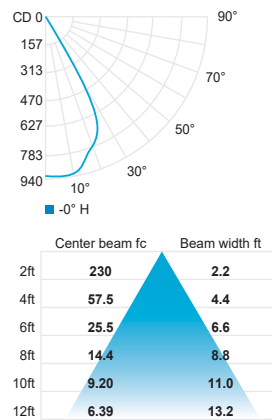

Wall washer (3000K, 90CRI)

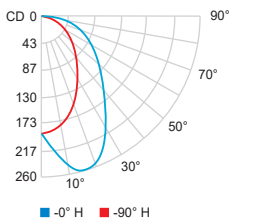

Wall washer LGC (3000K, 90CRI)

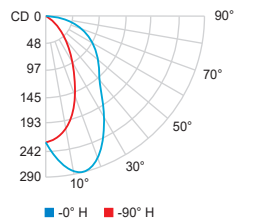

CCT options	2700K	3000K	3500K	4000K
CRI options	90CRI	90CRI	90CRI	90CRI
Multiplier	0.95	1	1	1.21

PHOTOMETRIC DATA

Photometric data for one laser blade module

LBXS10

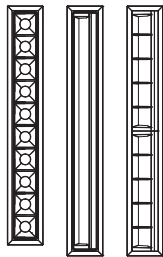

MD
FL
WF

CCT (K)	CRI	LOAD (W)	OPTIC	LUMENS (lm)	EFFICACY (lm / W)	MAX CANDELA (cd)	MODELS
3000K	90	23.8W	Medium 24°	1 422	59	6 570	LBXS10-930-MD
			Flood 41°	1 494	62	3 068	LBXS10-930-FL
			Wide flood 58°	1 494	62	1 904	LBXS10-930-WF
			Wall washer	627	26	470	LBXS10-930-WW
			Wall washer LGC (longitudinal glare control)	528	22	520	LBXS10-930-WL

Use multiplier table for other CCT and CRI output data. Efficacy based on IESNA LM-79 test reports. Visit iguzzini.com/us for complete photometric data.

Medium 24° (3000K, 90CRI)

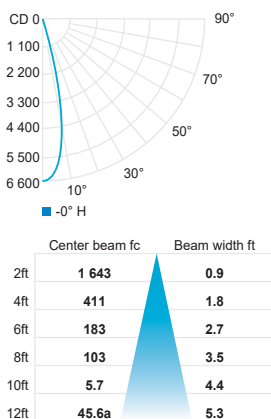

Flood 41° (3000K, 90CRI)

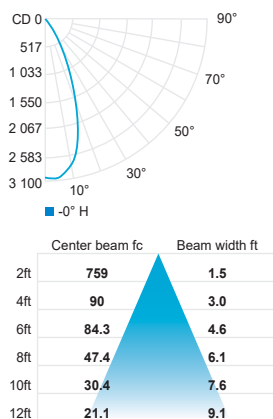

Wide flood 58° (3000K, 90CRI)

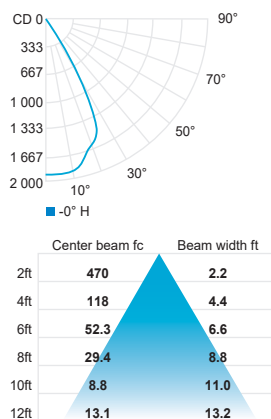

Wall washer (3000K, 90CRI)

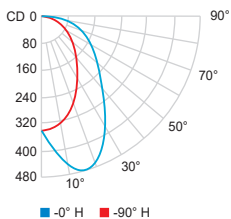

Wall washer LGC (3000K, 90CRI)

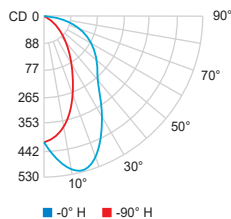

CCT options	2700K	3000K	3500K	4000K
CRI options	90CRI	90CRI	90CRI	90CRI
Multiplier	0.94	1	1	1.19

PHOTOMETRIC DATA

Photometric data for one laser blade module

LBXS15

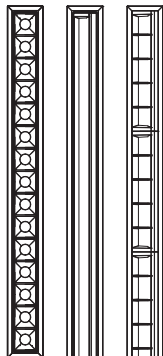

MD
FL
WF

CCT (K)	CRI	LOAD (W)	OPTIC	LUMENS (lm)	EFFICACY (lm / W)	MAX CANDELA (cd)	MODELS
3000K	90	34.5W	Medium 24°	2 133	61	9 855	LBXS15-930-MD
			Flood 41°	2 241	64	4 603	LBXS15-930-FL
			Wide flood 58°	2 241	64	2 856	LBXS15-930-WF
			Wall washer	912	26	684	LBXS15-930-WW
			Wall washer LGC (longitudinal glare control)	768	22	757	LBXS15-930-WL

Use multiplier table for other CCT and CRI output data. Efficacy based on IESNA LM-79 test reports. Visit iguzzini.com/us for complete photometric data.

Medium 24° (3000K, 90CRI)

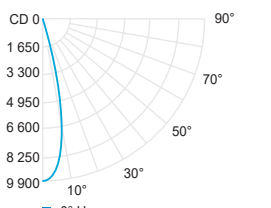

Flood 41° (3000K, 90CRI)

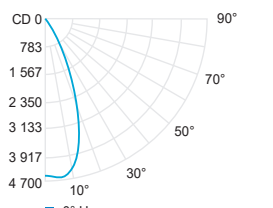

Wide flood 58° (3000K, 90CRI)

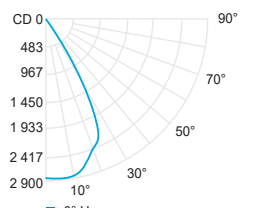

Wall washer (3000K, 90CRI)

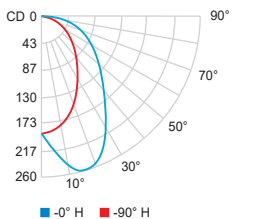

Wall washer LGC (3000K, 90CRI)

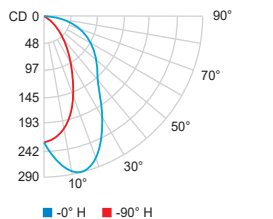

CCT options	2700K	3000K	3500K	4000K
CRI options	90CRI	90CRI	90CRI	90CRI
Multiplier	0.94	1	1	1.21