

Feeling enhances the lighting of outdoor spaces such as terraces and gardens, making them cosy and comfortable as if they were indoor spaces. A decorative lighting family for outdoors with a minimalist design for an elegant and charming ambient light. Feeling can be wall or ceiling mounted. Its thin stem can perform two different rotations: the first one, around its own axis, allows to direct the light beam, creating direct, indirect or lateral light effects; the second rotation, around the fixing joint, moves the lighting from a vertical position to a diagonal or horizontal position.

Luminaire characteristics

MODEL	POWER (W)	OPTIC	LUMENS (lm)*	EFFICACY (lm/W)*	MAX CANDELA (cd)*
S2280	11W	Accent light	290	26	106
S2281	17W		410	24	176

*For 3000K, 90CRI

Source: White LED
2700K: 90CRI,
3000K: 90CRI,
4000K: 90CRI.

Lumen maintenance: 80% of initial lumens at 70 000 hours (L80 B10)
Ta 77°F (25°C)
80% of initial lumens at 50 000 hours (L80 B10)
Ta 104°F (40°C) (LM-80)

Optics: Accent light.

Material: Base: Extruded anodized aluminum
Body: Die-cast aluminum
Hardware: Stainless steel screws
Diffuser: Opal silicone

Mounting: Wall and ceiling mounted on standard 4" octagonal junction box with round canopy.

Adjustement: 180° clockwise around its own axis.
350° stem rotation at the fixture base.

Electrical: High efficiency dimmable LED driver, rated at 50 000 hours

Dimming: Leading (Triac) and trailing edge (ELV), down to 15% (120V) and 0-10V down to 10% (120-277V).

Temperature of operation: -4°F to 122°F (-20°C to 50°C)

Finish: White or black painted finish. Double powder paint in 3 steps process: surface treatment containing ceramic nano particles (Bonderite). Epoxy primer paint. Polyester powder paint with high resistance against UV rays and harsh weather conditions. See page 2 for other premium finishes available (green, aluminium gray, burnish bronze & anthracite gray)

Standard finish

01 09

Premium finishes

07 14 20 24

Weight: 3ft (1m): 2.42lb (1.1kg)
6ft (2m): 3.20lb (1.4kg)

Warranty: 5 year limited warranty.

Ratings: IP54, IK06

Certification:  cULus for wet location

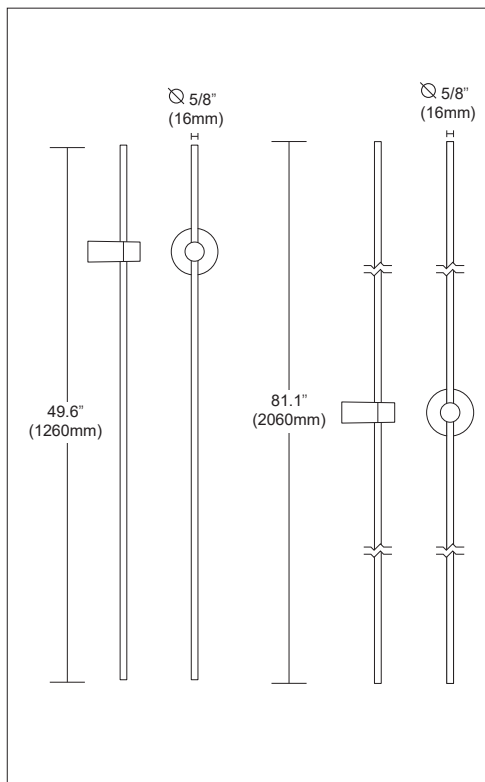
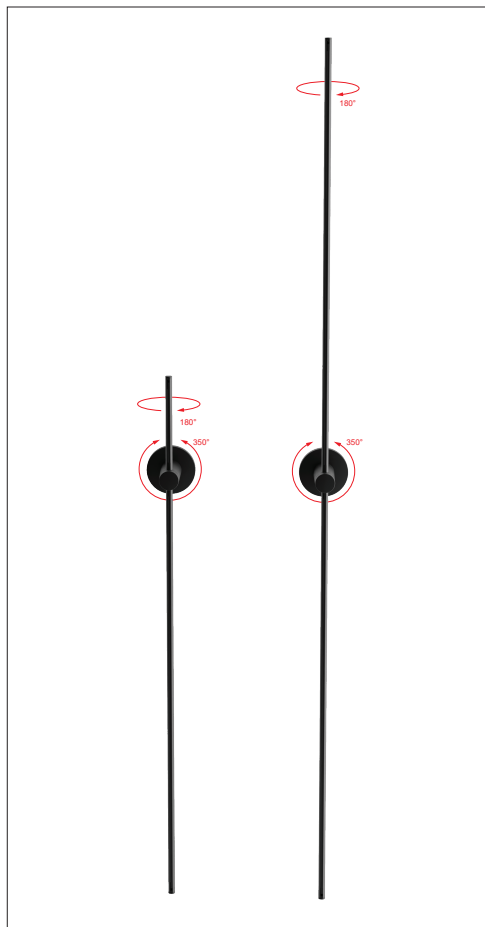

ORDERING INFO



PRODUCT CODE					
MODEL	LED	MOUNTING	VOLTAGE	FINISH	DIMMING
S2280 1m (49.6")	H 2700K, 90CRI	JB Surface mounted junction box	UNV 120-277V	01 White	D10¹ 0-10V
S2281 2m (81.1")	W 3000K, 90CRI			09 Black	
	N 4000K, 90CRI			<i>PREMIUM</i>	
				07 Green	
				14 Aluminium Gray	
				20 Burnished bronze	
				24 Anthracite gray	

1 The driver achieve Triac and ELV dimming in 120V and 0-10V dimming in 120 and 277V.

DIMENSIONS

Canopy dimensions and fixture rotations are shown in a single model to simplify the layout, but are the same for both models

S2280 (1m)

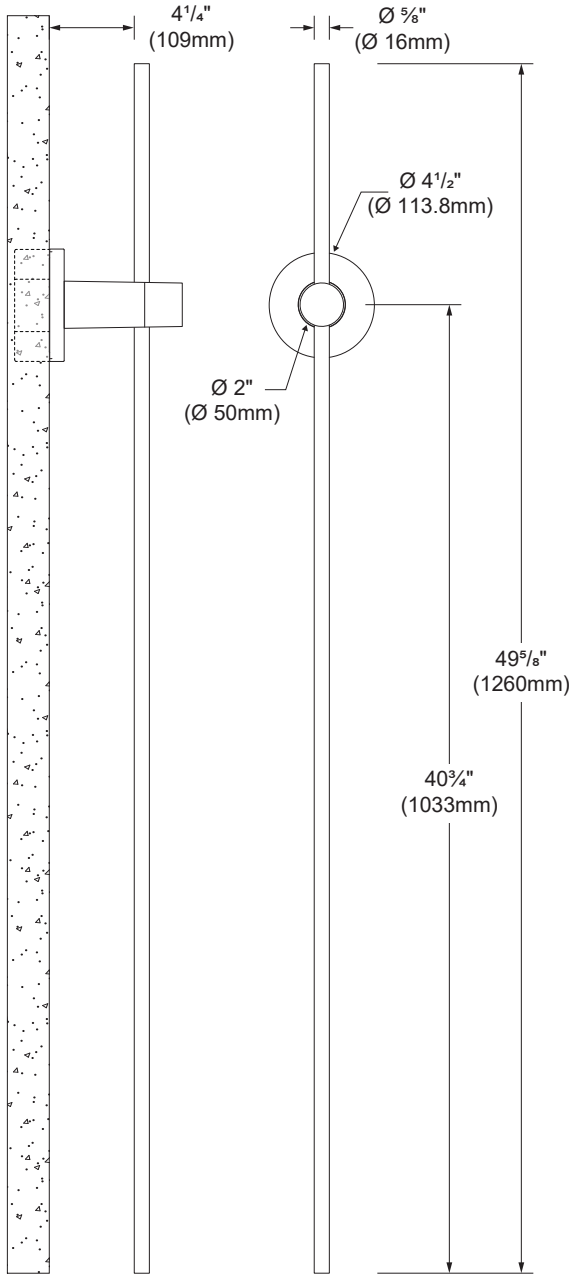

SIDE VIEW

FRONT VIEW

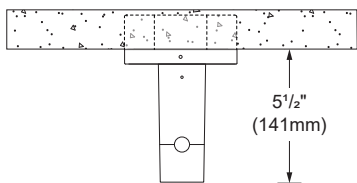

**TOP VIEW
JB-UNV**

S2281 (2m)

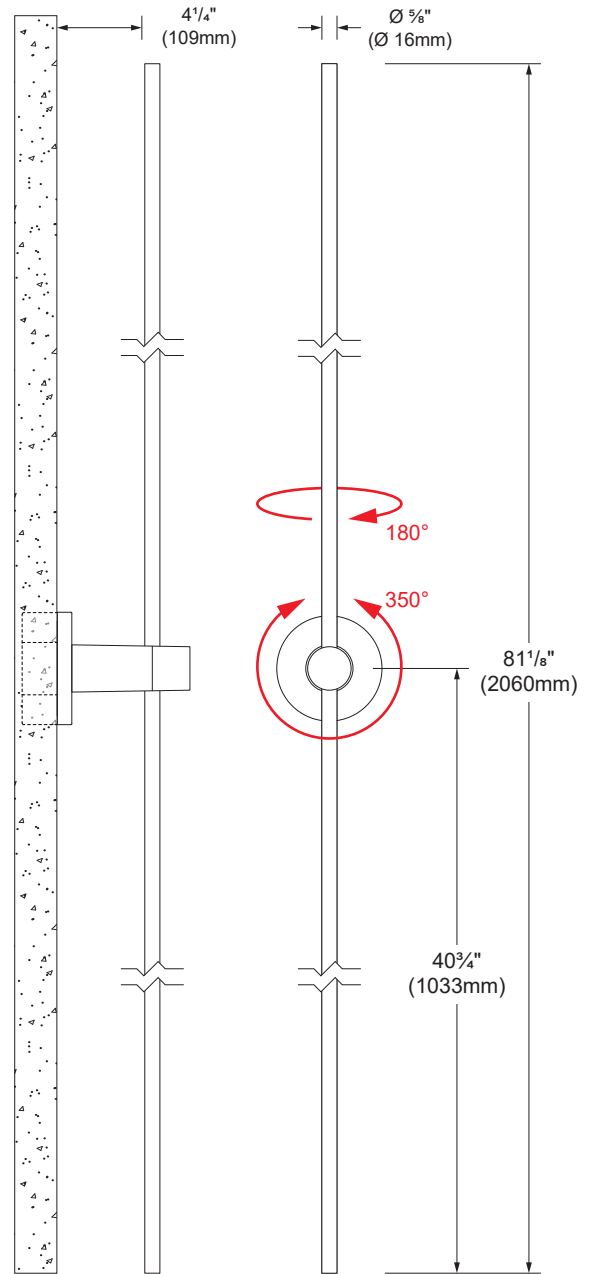

SIDE VIEW

FRONT VIEW

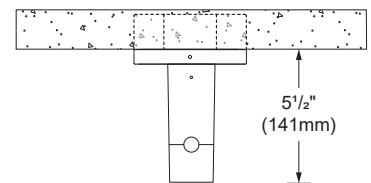

**TOP VIEW
JB-UNV**

PHOTOMETRIC DATA

CCT (K)	CRI	POWER (W)	OPTIC	LUMENS (lm)	EFFICACY (lm / W)	MAX CANDELA (cd)	MODELS
3000K	90	11W	Accent light	290	26	106	S2280W
		17W		410	24	176	S2281W

S2280W (3000K, 90CRI)

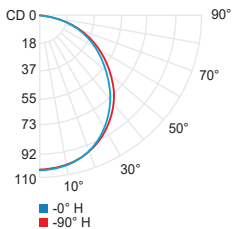

S2281W (3000K, 90CRI)

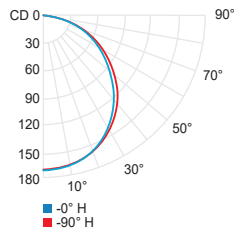

CCT options	2700K	3000K	4000K
CRI options	90CRI	90CRI	90CRI
Multiplier	0.95	1	1.15

Use a multiplier table for the other CCT and CRI output data. Efficacy based on IESNA LM-79 test reports.