

Collection of specification grade downlights for architectural applications. Excellent build quality with features for the most demanding professional applications. Available in four sizes 3", 4", 5", 6" aperture with generous light outputs and excellent chromatic performance. Professional optics available with general downlight, directional or wall washer distribution.

**Luminaire characteristic:**

**Power input:** 15.5W, 21.5W or 29W  
**Lumens:** up to 1810lm (for 3000K, 80CRI)  
**Luminaire efficacy:** Up to 67lm/W

**Source:** COB LED module (LM-80)  
2700K: 90CRI, 97CRI,  
3000K: 80CRI, 90CRI, 97CRI,  
3500K: 80CRI, 90CRI,  
4000K: 80CRI.

**Lumen maintenance:** LM79,  
90% of initial lumens at 50 000 hours (L90),  
80% of initial lumens at 100 000 hours (L80).

**Optic:** **Fixed:** Deep recessed reflector available with spot or flood optic.  
**Adjustable:** Deep recessed reflector available with spot or flood optic. Optical assembly hot aiming adjustment: 30° tilt and 359°pan.  
**Wall Washer:** Wall washer.

**Material:** Body: Die-cast aluminum optical assembly  
Reflector: Metalized polycarbonate  
Baffle: Painted polycarbonate

**Mounting:** Remodel or new construction with plaster frame. See page 3 for details.

**Electrical:** Integral high efficiency power supply rated at 50 000 hours, 120V or 277V.

**Dimming:** Leading edge (TRIAC), trailing edge (ELV) and 0-10V, down to 15%,  
0-10V, down to 1%,  
Lutron Hi Lume® 1% EcoSystem™ (Soft-on, Fade to Black),

**Finish:** Powder coated body and baffle. See page 2 for details.

**Weight:** 3.8lbs (1.72kg)

**Warranty:** 5 year limited warranty.

**Rating:** IP54

**Certification:**  cULus listed for Damp location.

**ORDERING INFO**

**LOG5** - -  
FIXTURE

- **LOG5** -  
HOUSING

**MODEL**

- R** - Round       **S** - Square

**MOUNTING**

- T** - Trim       **L** - Trimless

**INSTALLATION**

- RF** - Remodeling (No housing)       **NC** - new construction plaster frame

**OUTPUT**

- E** - High Efficiency (15.5W)     **B** - Base Output (21.5W)     **H** - High Output (29W)

**LED**

- 927** - 2700K, 90 CRI     **830** - 3000K, 80 CRI     **835** - 3500K, 80 CRI     **840** - 4000K, 80 CRI<sup>(1)</sup>  
 **027** - 2700K, 97 CRI     **930** - 3000K, 90 CRI     **935** - 3500K, 90 CRI  
 **030** - 3000K, 97 CRI<sup>(1)</sup>

**OPTIC**

- FSP** - Fixed, Spot     **FFL** - Fixed, Flood     **ASP** - Adjustable, Spot     **AFL** - Adjustable, Flood     **WW** - Wall Washer<sup>(2)</sup>

**VOLTAGE**

- 120** - 120V     **277** - 277V

**FINISH** (trim finish / baffle finish)

- |  |   |  |  |   |
|--|---|--|--|---|
| <b>White trim</b>  | <b>Gray trim</b>  | <b>Black trim</b>  | <b>Trimless</b>  |   |
| <input type="checkbox"/> <b>01</b> - White / white                         | <input type="checkbox"/> <b>20</b> - Gray / white                         | <input type="checkbox"/> <b>23</b> - Black / white                         | <input type="checkbox"/> <b>01</b> - White                         |  |
| <input type="checkbox"/> <b>21</b> - White / black                         | <input type="checkbox"/> <b>22</b> - Gray / black                         | <input type="checkbox"/> <b>02</b> - Black / black                         | <input type="checkbox"/> <b>02</b> - Black                         |   |
| <input type="checkbox"/> <b>13</b> - White / matte anodized <sup>(2)</sup> | <input type="checkbox"/> <b>03</b> - Gray / matte anodized <sup>(2)</sup> | <input type="checkbox"/> <b>33</b> - Black / matte anodized <sup>(2)</sup> | <input type="checkbox"/> <b>51</b> - Matte anodized <sup>(2)</sup> |   |

**DIMMING**

- D10** - 0-10V (down to 15%)<sup>(3)</sup>     **LTE** - Leading and Trailing edge dimming (120V only) (down to 15%)<sup>(3)</sup>     **D2B** - Lutron Hi Lume® 1% EcoSystem™ (Soft-on, Fade to Black)<sup>(3)</sup>  
 **D01** - 0-10V (down to 1%)

<sup>(1)</sup> LED options may require a longer lead time than standard. Please contact factory for details.  
<sup>(2)</sup> Wall washer version only available in matte anodized finish.  
<sup>(3)</sup> Dimming levels will vary depending the dimmer used and the number of luminaires on the line.

**ACCESSORY**

(TO BE ORDERED SEPARATELY)

- 9002-02** - Black hex cell louver



**INSTALLATION**

**Remodel (RF)**

Versatile fixture for new or existing ceiling structure. Suitable for non-insulated ceiling assemblies, like sheetrock, or paneling. Fixture is ready for remodeling installation. Trimless frame and fixture can be shipped separately.

**Ceiling thickness:** 1/8" to 1 1/4" (3mm - 32mm)  
**Total weight:** 3.8lbs (1.72kg)

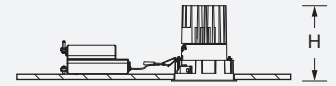

Model		Trimless frame	Cut-out dimensions	Clearance (H)
LOG5R	TR		Ø 5" (Ø 125mm)	7 1/2" (190mm)
	TL	TK-LOG5RL-RF*	Ø 5 1/8" (Ø 130mm)	
LOG5S	TR		4 7/8" x 4 7/8" (122 x 122mm)	
	TL	TK-LOG5SL-RF*	5" x 5" (125 x 125mm)	

\*Can be installed from below the ceiling.

**New construction with plaster frame (NC)**

Plaster frame with hanger bars system to be installed during rough-in phase. Suitable for non-insulated ceiling assemblies, like sheetrock, or paneling. Plaster frame and trim can be shipped separately.

**Ceiling thickness:** 1/8" to 1 1/4" (3mm - 32mm)  
**Total weight:** 5lbs (2.27kg)

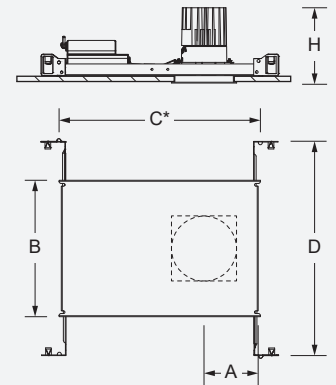

\*Provide a minimum of 1/8" (46mm) on each side for the hanger bar fixations

Model	Plaster frame	Cut-out dimensions	Cut-out position (A)	Overall dimensions (BxC)	Hanger bars (D)	Clearance (H)
LOG5R	BN-LOG5RT-NC	Ø 5" (Ø 125mm)	3/4" (95mm)	8 5/8" x 15 5/8" (219 x 397mm)	14 1/4" to 26" (362 to 660mm)	7 1/2" (190mm)
	BN-LOG5RL-NC	Ø 5 1/8" (Ø 130mm)				
LOG5S	BN-LOG5ST-NC	4 7/8" x 4 7/8" (122 x 122mm)				
	BN-LOG5SL-NC	5" x 5" (125 x 125mm)				

**MODEL**

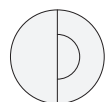
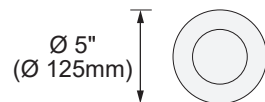
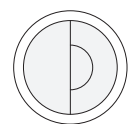
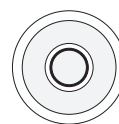
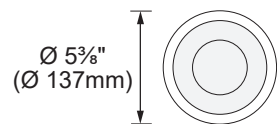
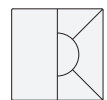
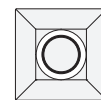
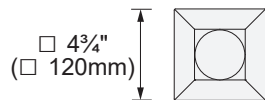
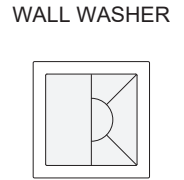
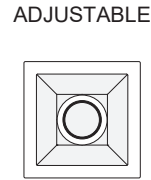
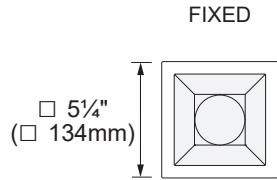

**BAFFLE DEPTH**

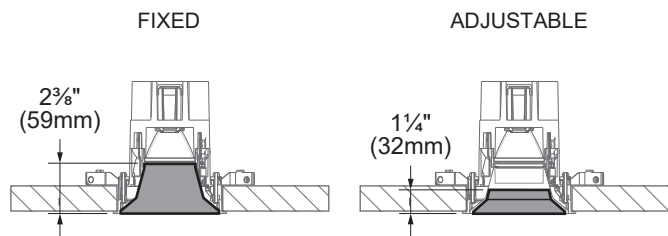

**TRIMLESS FRAME KIT**

Trimless frame kit to be fastened to the gypsum board. The assembly is then finished by plastering, sanding and painting. Install the luminaire inside the opening once painting is completed. The kit is sold separately for retrofit installation or supplied with the plaster frame for new construction installations.

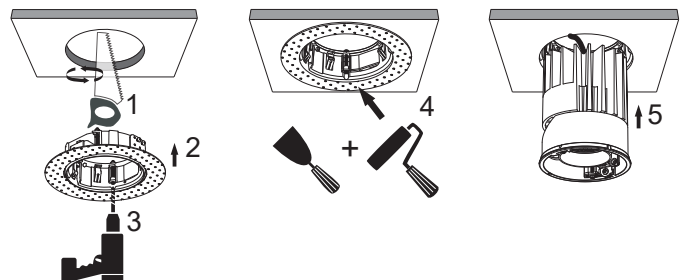

**LED COLOR FIDELITY DATA**

CRI	CCT	R1	R2	R3	R4	R5	R6	R7	R8	R9	R10	R11	R12	R13	R14	R15	Rf	Rg	Melanopic ratio
80	3000K	81	92	96	81	82	90	82	58	5	82	81	73	84	98	-	85	95	0.528
	3500K	82	91	96	82	82	89	84	62	8	80	81	68	85	99	-	85	95	0.609
	4000K	82	91	96	82	83	87	86	65	11	78	82	65	85	98	-	85	95	0.694
90	2700K	94	98	99	94	95	98	91	82	61	95	96	88	96	99	-	93	99	0.497
	3000K	94	97	99	94	94	96	93	83	62	92	95	84	95	99	-	93	99	0.563
	3500K	93	96	98	93	93	95	93	84	62	90	94	78	94	98	-	92	98	0.642
97	2700K	100	99	96	98	99	98	98	96	90	96	97	89	100	96	-	96	101	0.497
	3000K	99	98	95	98	98	97	98	97	90	93	97	84	99	96	-	95	101	0.563

**PHOTOMETRIC DATA**

Visit [sistimalux.com](http://sistimalux.com) for complete photometric data.

**FIXED / ADJUSTABLE**

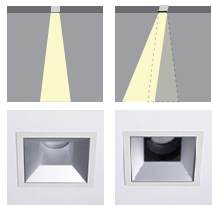

CCT (K)	CRI	OUTPUT	LOAD (W)	OPTIC	LUMENS (lm)	EFFICACY (lm / W)	MAX CANDELA (cd)
3000K	80	HE	15.5W	Spot	1040	67	5 535
				Flood	900	58	1 870
		BO	21.5W	Spot	1330	61	7 095
				Flood	1155	53	2 395
		HO	29W	Spot	1810	62	9 630
				Flood	1570	54	3 255

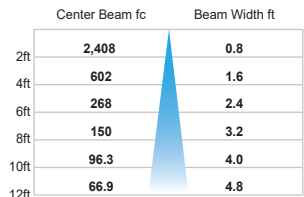

3000K - HO - 80 CRI - 29W - Spot 20°

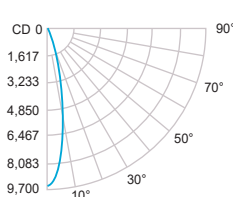

■ -0° H

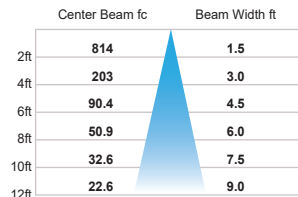

3000K - HO - 80 CRI - 29W - Flood 40°

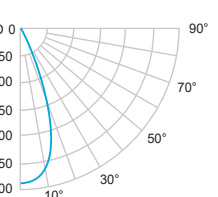

■ -0° H

**WALL WASHER**



CCT (K)	CRI	OUTPUT	LOAD (W)	OPTIC	LUMENS (lm)	EFFICACY (lm / W)	MAX CANDELA (cd)
3000K	80	HE	15.5W	Wall washer	685	44	575
		BO	21.5W		880	40	735
		HO	29W		1195	41	1 000

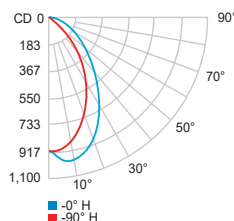

3000K - HO - 80 CRI - 29W - Wall Washer

\*USE MULTIPLIER TABLE FOR OTHER CCT AND CRI OUTPUT DATA

CCT options	2700K	2700K	3000K	3000K	3000K	3500K	3500K	4000K
CRI options	90CRI	97CRI	80CRI	90CRI	97CRI	80CRI	90CRI	80CRI
Multiplier	<b>0.79</b>	<b>0.72</b>	<b>1</b>	<b>0.79</b>	<b>0.75</b>	<b>1.01</b>	<b>0.84</b>	<b>1.03</b>